



*Digital Monochrome 2 Megapixel  
Progressive Scan Camera*

**CV-M2**

---

# *Operation Manual*

*Camera: Revision A  
Manual: Version 1.0*

Table of Contents

1. General ..... 2

2. Standard Composition ..... 2

3. Main Features ..... 2

4. Locations and Functions ..... 3

5. Pin Assignment..... 4

    5.1. 12-pin Multi-connector (DC-IN/Trigger) ..... 4

    5.2. BNC connector for analogue monitor video output..... 4

    5.3. Digital Output Connector for Camera Link..... 4

    5.4. Input and Output Circuits..... 5

        5.4.1. Monitor video output ..... 5

        5.4.2. Iris video output..... 5

        5.4.3. Trigger input..... 5

        5.4.4. EEN output ..... 5

        5.4.5. Camera Link interface ..... 6

6. Functions and Operations ..... 7

    6.1. Basic functions ..... 7

        6.1.1. Dual video output ..... 7

        6.1.2. Burst trigger ..... 7

        6.1.3. Restart continuous trigger mode ..... 8

        6.1.4. PIV mode ..... 8

        6.1.5. Sensor Gate Control ..... 9

        6.1.6. Digital video out allocation ..... 10

        6.1.7. Knee function..... 10

    6.2. Sensor layout and timing. .... 11

        6.2.1. CCD sensor layout..... 11

        6.2.2. Vertical timing ..... 11

        6.2.3. Horizontal timing single channel ..... 12

        6.2.4. Horizontal timing details single channel ..... 12

        6.2.5. Horizontal timing dual channel..... 13

        6.2.6. Horizontal timing details dual channel..... 13

        6.2.7. LVAL synchronous accumulation..... 14

        6.2.8. LVAL a-synchronous accumulation ..... 15

        6.2.9. Partial scanning vertical timing ..... 16

    6.3. Input/Output of Timing Signals..... 17

        6.3.1. Input of Timing Signals..... 17

        6.3.2. Output of Timing Signals..... 17

    6.4. Trigger Modes..... 17

        6.4.1. Continuous Operation (Non triggered) ..... 18

        6.4.2. Edge Pre-select Mode ..... 19

        6.4.3. Restart Continuous Trigger mode ..... 20

        6.4.4. Pulse Width Control Mode ..... 21

        6.4.5. Burst Trigger mode ..... 22

        6.4.6. PIV mode. .... 23

        6.4.7. Sensor Gate Control ..... 24

    6.5. Other Functions. .... 25

7. Configuring the Camera ..... 26

    7.1. Mode setting SW1 on rear ..... 26

    7.2. RS-232C/Camera Link switch..... 26

    7.3. Internal Switch ..... 26

    7.4. RS-232C control ..... 27

    7.5. CV-M2 command list..... 28

    7.6. Camera Control Tool for CV-M2..... 29

8. External Appearance and Dimensions ..... 30

9. Specifications ..... 30

    9.1. Spectral sensitivity ..... 30

    9.2. Specification table..... 31

10. Appendix ..... 32

11. Users Record..... 33

### 1. General

The CV-M2 is a digital 2 megapixel camera designed for automated imaging and ITS (Intelligent Traffic Systems) applications, featuring high resolution and high speed within a uniform and compact housing.

The high-speed shutter function, asynchronous random trigger mode and partial scan mode allows the camera to capture high quality images of fast moving objects with a high frame rate. Functions like burst trigger, reset continuous trigger mode, analog iris video output, knee and gamma function for single channel makes the camera suitable for intelligent traffic systems. The CV-M2 features the Camera Link standardized multiplexed signal output interface.

The latest version of this manual can be downloaded from: [www.jai.com](http://www.jai.com)

The latest version of Camera Control Tool for CV-M2 can be downloaded from: [www.jai.com](http://www.jai.com)

For camera revision history, please contact your local JAI distributor.

### 2. Standard Composition

The standard camera composition consists of the camera main body and tripod mount plate.

### 3. Main Features

- Digital 1" monochrome 2 megapixel progressive scan CCD camera
- 1600 (h) x 1200 (v) effective 7.4  $\mu$ m square pixels
- 10 or 8 bit video output as Camera Link
- 17 full frames/second for single channel video readout
- 30 frames/second with dual channel video readout
- One push black level and gain calibrations for dual channel readout
- Higher frame rates with 1/2, 1/4 and 1/8 partial scanning
- Programable partial scanning with 1 line interval for start position and scanned lines
- Edge pre-select and pulse width controlled external trigger modes
- Shutter speed 1/17 (off) to 1/14,000 second in 10 steps
- Programable exposure by edge pre-select shutter 1.5H to 1216.5H with 1 H interval
- Burst trigger for 5 different edge pre-selected exposures in sequence
- Analogue video output for iris control
- Restart continuous trigger mode (RCT) makes it ideal for traffic control (ITS)
- Analog composite video output for CCIR/EIA monitor
- PIV mode (Particle Image Velocimetry) for 2 short exposures with very short interval
- Short ASCII commands for fast mode setup via serial port
- Setup by Windows 98/NT/Win2000 via RS-232C or Camera Link

4. Locations and Functions

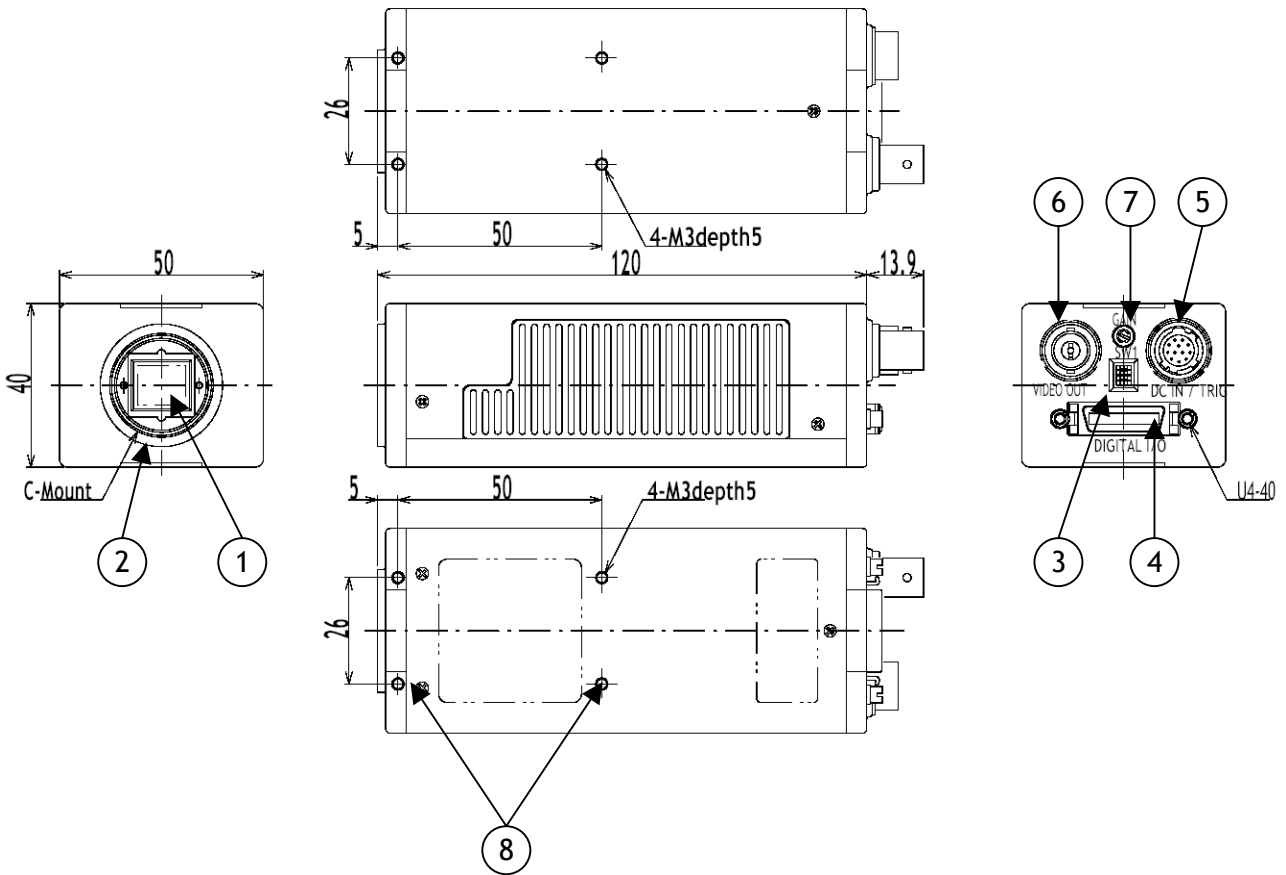

1. CCD sensor
2. Lens mount (C-mount)
3. Rear panel with SW1
4. Digital output connector (Camera Link)
5. DC in/Trigger in/RS-232C connector
6. BNC connector for monitor video output
7. Gain potentiometer
8. Mounting holes M3. (8x)

Fig. 1. Locations

## 5. Pin Assignment

### 5.1. 12-pin Multi-connector (DC-IN/Trigger)

Type: HR10A-10R-12PB-01  
(Hirose) male.  
(Seen from rear of camera.)

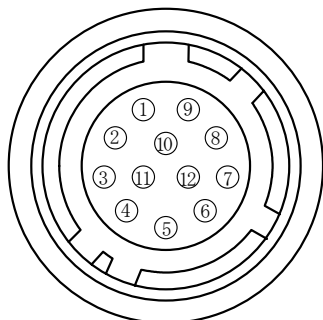

Fig. 2. 12-pin connector.

Pin no.	Signal	Remarks
1	GND	
2	+12 V DC input	
3	GND	
4	Iris Video output	Analogue video for iris control in continuous mode and RCT mode. *)
5	GND	
6	RXD in	RS 232C. Or via Camera Link
7	TXD out	By internal switch HR/CL (Refer to 7.2)
8	GND	
9	EEN out	Or via Camera Link
10	Trigger/SG input	TI=1. (Or via Camera Link if TI=0 ) SG=0 trigger input. SG=1 sensor gate contr.
11	Factory use	For factory test
12	GND	

\*) Refer to 5.4.2. for Iris video output. SG = Sensor Gate Control.

### 5.2. BNC connector for analogue monitor video output

On the BNC connector an analogue video signal (CCIR or EIA) for monitoring is found if OS=2. The signal can be viewed on a standard monitor as 50 FPS/15.734 kHz 290 lines if MN=1, or 60 FPS/15.734 kHz 240 lines if MN=0. It is non-interlaced and for single channel only. The image covers the full format, but the resolution is much lower than the digital video output.

### 5.3. Digital Output Connector for Camera Link

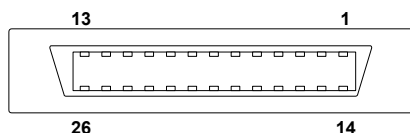

Type: 26 pin MRD connector  
3M 10226-1A10JL

Fig. 3. Camera Link connector

The digital output signals follow the Camera Link standardized multiplexed signal output interface. The output driver is NS type DS90CR285, and the receiver is NS type DS90CR286.

The following signals are found on the Digital Output Connector:

SerTC	RXD serial data to camera	(Int. switch HR/CL. Refer to 7.2)
SerTFG	TXD serial data to frame grabber	(Int. switch HR/CL. Refer to 7.2)
CC1	Trigger/Sensor Gate input	(TI=0 for CL. SG=1 for Sensor Gate)
CC2	Factory use	
X0 to X3	Camera Link multiplexed data out	
Xclk	Camera Link clock. Used as pixel clock.	

In the Channel Link X0 to X3 multiplexed signals the following signals are encoded.

D0 - D9	2 x 10 bit video data out for right and left channel.
LVAL	Line VALid. Video line data is valid.
FVAL	Frame VALid. Video frame data is valid.
DVAL	Data VALid. Effective video pixel data is valid
EEN	Exposure ENable. (Not specified by Camera Link).

LVAL, FVAL, DVAL polarity is positive. EEN is negative. TRIG is negative as factory setting. TRIG polarity can be changed by TP. For Camera Link interface principle diagram please check Fig. 7.

## 5.4. Input and Output Circuits

### 5.4.1. Monitor video output

On the BNC connector an analogue video signal for set-up is found if OS=2. The signal can be used for focus and field of view adjust.

CCIR if MN=1. (50 fps, 17.734 kHz, 290 active lines.)

EIA if MN=0. (60 fps, 17.734 kHz, 262 active lines.)

It is for single channel normal (TR=0) operation only.

Shutter speed <313 LVAL (CCIR). <263 LVAL (EIA).

Video is composite 1Vpp from a 75 Ω source.

### 5.4.2. Iris video output

The analogue video output without composite sync on pin #4 12 pin Hirose connector is a 75 Ω DC coupled circuit. It can be used for iris control if the camera is in normal continuous mode or Reset Continuous Trigger mode. It is for single channel only.

Black level is 0.5 volt without termination.

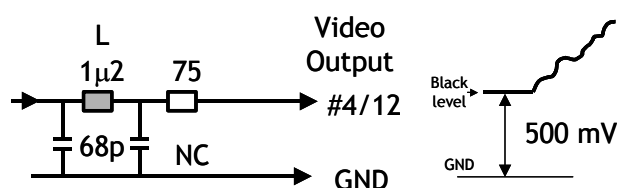

#### **Important note on using this signal for iris control.**

The signal for iris video output is taken from the video signal after the gain control. If it is used for auto iris control, output video level can only be adjusted on the lens level adjust.

Fig. 4. Video output.

### 5.4.3. Trigger input

The trigger inputs on pin #10 12 pin Hirose connector is AC coupled. To allow a long pulse width, the input circuit is a flip flop, which is toggled by the negative or positive differentiated spikes caused by the falling or rising trigger edges.

The trigger polarity can be changed.

Trigger input level 4 V ±2 V.

The trigger-input impedance is 10 kΩ.

The trigger inputs can be changed to Camera Link input.

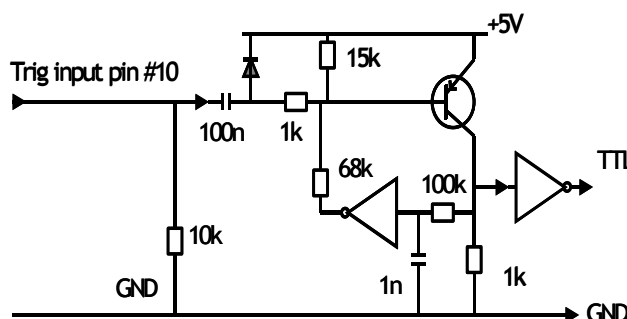

Fig. 5. Trigger input.

### 5.4.4. EEN output

On pin #9 on 12 pin Hirose connector EEN The output circuit is 75 Ω complementary emitter followers. It will deliver a full 5 volt signal.

Output level ≥4 V from 75Ω. (No termination).

EEN output is also on Camera Link.

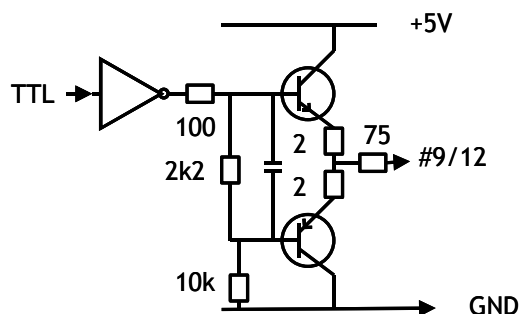

Fig. 6. EEN output

5.4.5. Camera Link interface

The video output is Camera Link, where the 2 channels with 10 or 8 bit video are placed in a base configuration. The digital output signals follow the Camera Link standardized multiplexed signal output interface. The output driver is NS type DS90CR285, and the receiver is NS type DS90CR286.

The data bits from the digital video, FVAL, LVAL, DVAL and EEN are multiplexed into the twisted pairs, which are a part of the Camera Link. Trigger signals and the serial camera control are feed directly through its own pairs. The trigger input can also be TTL on the 12 pin connector. (TI=0 for CL. TI=1 for 12 pin). The serial camera control can be switches between the 12 pin connector or CL by an internal switch HR/CL. Refer to 7.2

The 26 pin MDR connector pin assignment follows the Camera Link base configuration.

For a detailed description of Camera Link specifications, please refer to the Camera Link standard specifications found on [www.jai.com](http://www.jai.com)

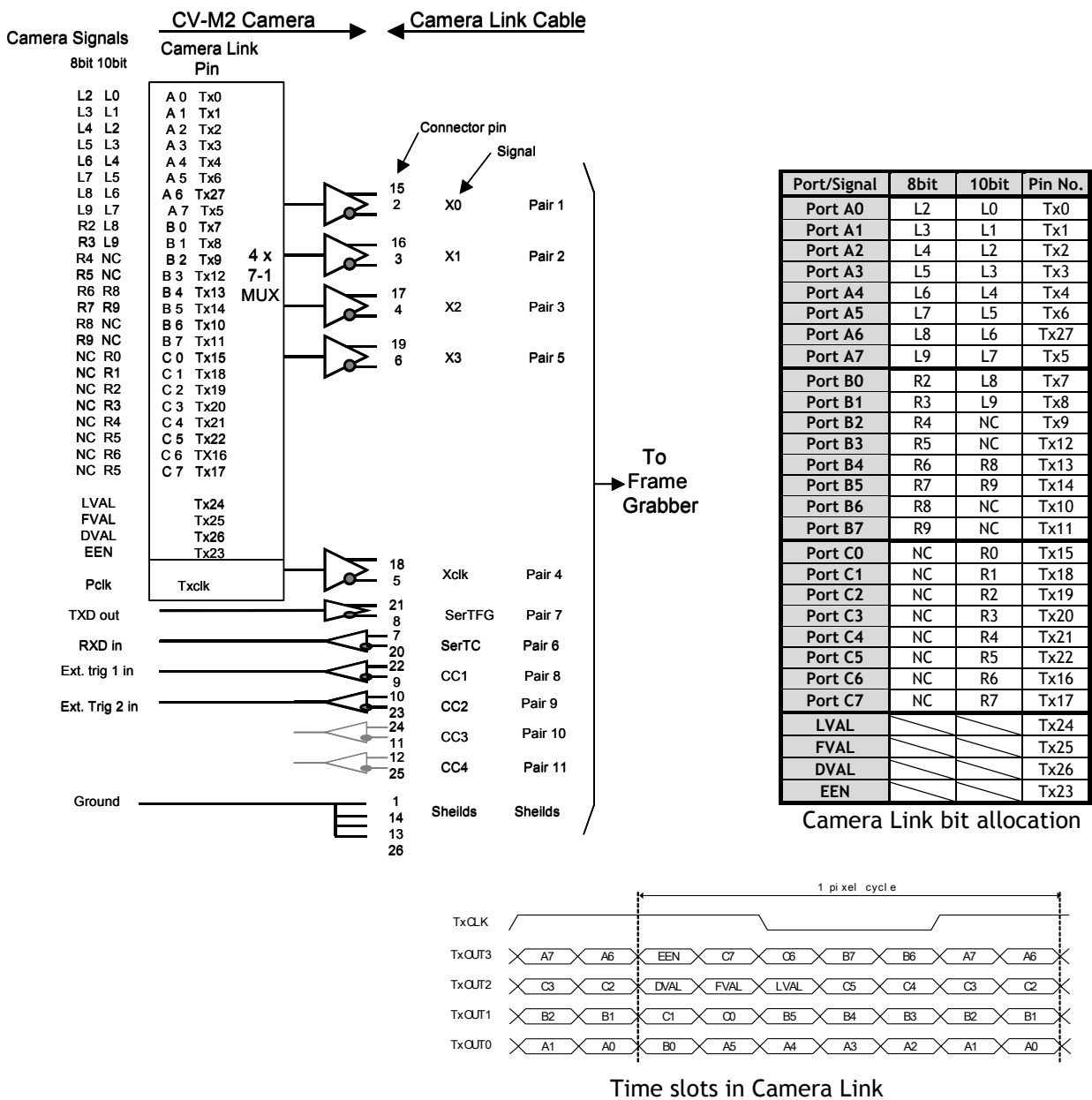

Fig. 7. Principle diagram for Camera Link base configuration interface

## 6. Functions and Operations

In the following the format shown in "7.5. CV-M2 command list" are used for function commands and parameters.

### 6.1. Basic functions

The M2 camera is a progressive scan camera with 10 or 8 bit video output in single or dual channel Camera Link. On a BNC connector a standard composite video output CCIR or EIA for monitor use is found. The image covers the full format, but the resolution is much lower than the digital video output.

An iris video signal can be used for lens iris control if the camera is in continuous mode or Reset Continuous Trigger mode.

A knee function (and gamma for single channel) makes it possible to cover high contrast scenes. The CV-M2 camera has 1/2, 1/4 or 1/8 partial scanning. Programmable partial scan, where the start line and the number of lines can be selected in 1line increments is also available.

There are 5 trigger modes. Normal continuous, reset continuous trigger, edge pre-select, pulse width control, edge pre-select burst trigger and PIV trigger. (PIV, Particle Image Velocimetry).

The Sensor Gate Control can be used in normal continuous mode together with strobe flash. The accumulation can be LVAL synchronous or LVAL a-synchronous.

In the following some of the functions are shown in details.

#### 6.1.1. Dual video output

The video read out through Camera Link can be via a single or via double channels. (OS=0 for single channel, OS=1 for dual channel.) If dual video outputs are used, the frame grabber PC should reconstruct the image frame from the 2 half images.

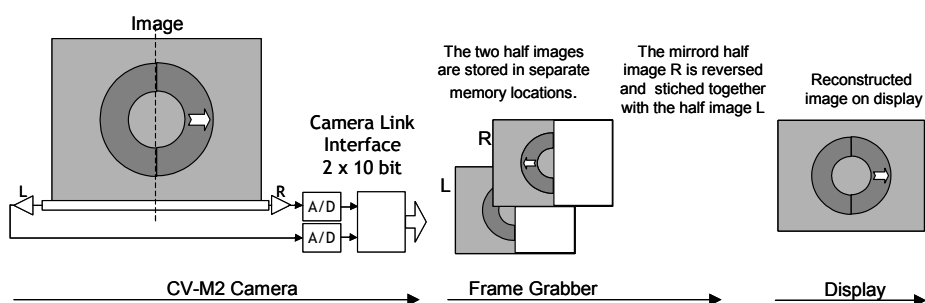

Fig. 8. Dual channel read out

#### 6.1.2. Burst trigger

With the burst trigger function TR=4, five previous set edge pre-selected programmable exposures can be done with a single trigger pulse. The five shutter times can be set with BSH1 through BSH5. (1H through 1216H.)

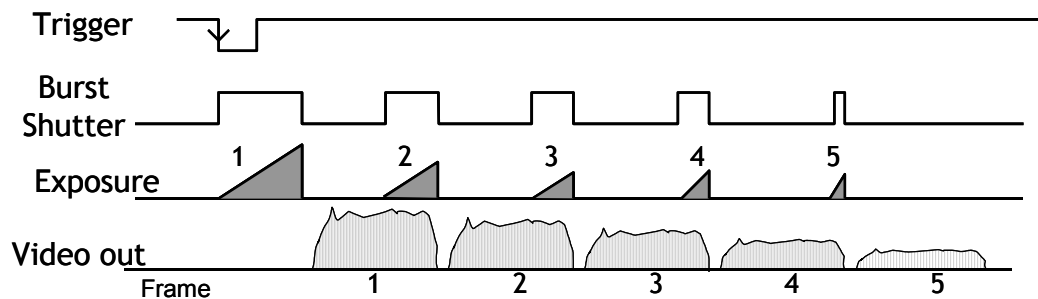

Fig. 9. Burst trigger



### 6.1.3. Restart continuous trigger mode

The RCT mode makes it possible to use a lens with video controlled iris for intelligent traffic surveillance applications. TR=2. The camera is running continuously, and the iris is controlled from the iris video output. When a trigger pulse is applied, the scanning is reset and restarted, the previous signal is dumped with a fast dump read out, and the new triggered exposure is started. This fast dump read out has the same effect as "smearless read out". Smear over highlighted areas are reduced for the triggered frame.

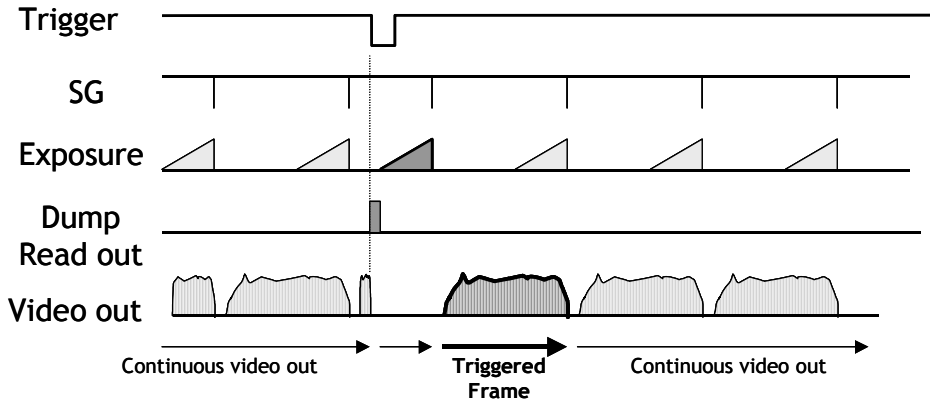

Fig. 10. Restart continuous trigger mode

### 6.1.4. PIV mode

The Particle Image Velocimetry mode can be used in applications where 2 images should be taken with a very short time interval. TR=5. It can only be used with strobe flash or lasers as illumination. The first accumulation time is 4  $\mu\text{sec}$ . The second is as long as the time for a full frame.

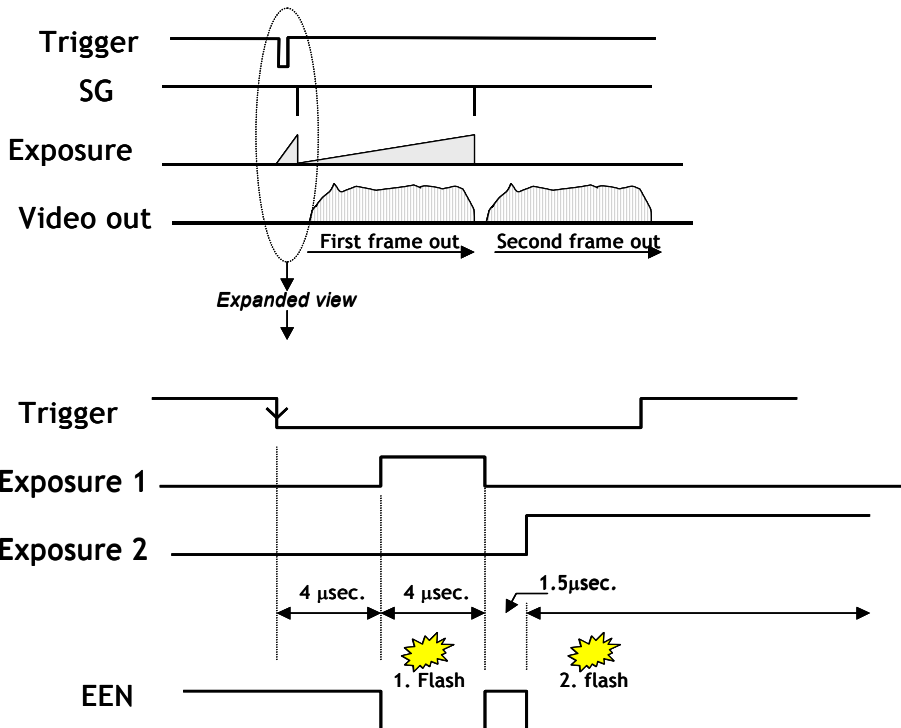

Fig. 11. PIV mode

### 6.1.5. Sensor Gate Control

This function is for applications where a strobe flash is the only illumination, and where the exact time for the strobe firing is not known. The time window for the strobe firing can be up to several frames. The resulting video read out can also be delayed by this function. It makes the synchronization of the frame grabber more flexible.

The Sensor Gate Control signal will inhibit the internal SG signal so the accumulation can continue. The sensor gate control signal can be synchronized by the FVAL signal.

This function will only work in normal continuous mode. TR=0. The function is on if SG=1.

The SG signal is an internal signal, which is low when the accumulated charge on the photo diode array is transferred to the vertical ccd registers for read out.

When the Sensor Gate Control input is high, the internal SG pulse is inhibited, and the signal accumulation on the photo diode array can take place. When the strobe flash is fired, the Sensor Gate Control signal can be low. The resulting video is then read out after the first FVAL (or SG), following the falling edge of Sensor Gate Control signal.

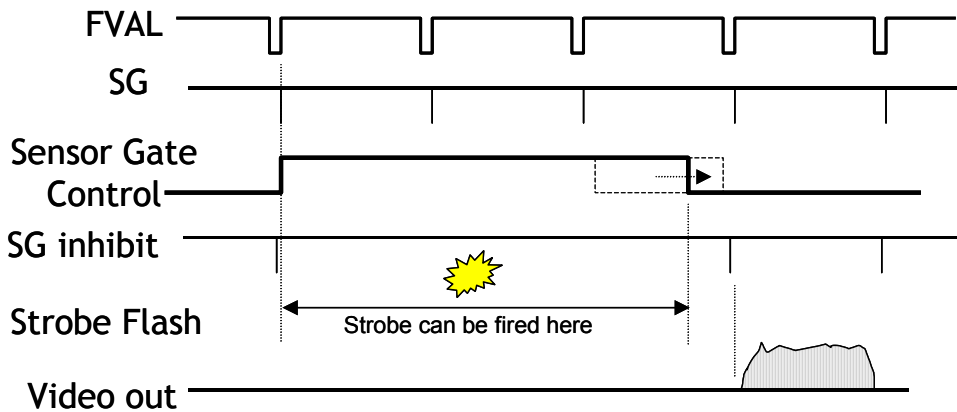

Fig. 12. Sensor Gate Control

### 6.1.6. Digital video out allocation

The set-up and the relations between the analog and digital video are shown in fig. 13.

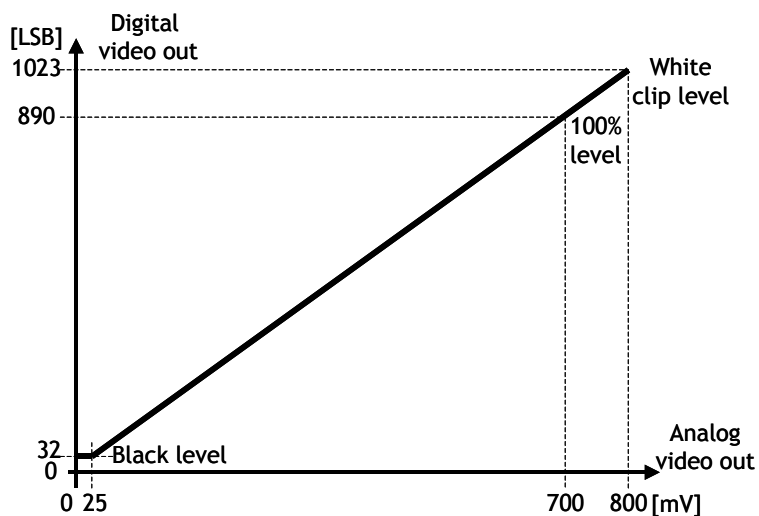

Fig. 13. Digital video bit allocation

### 6.1.7. Knee function.

The knee functions can compress the signals in the highlighted areas. The slope over the knee point is only 20%. The Knee point can be adjusted from 712 to 1023. With the knee at 890, the camera can reproduce scene highlight up to 175%. The image contrast is reduced to 20% for scene luminance higher than the knee point.

This function can be used in applications where the scene brightness is divided in an area in shadow, and another in bright sunshine.

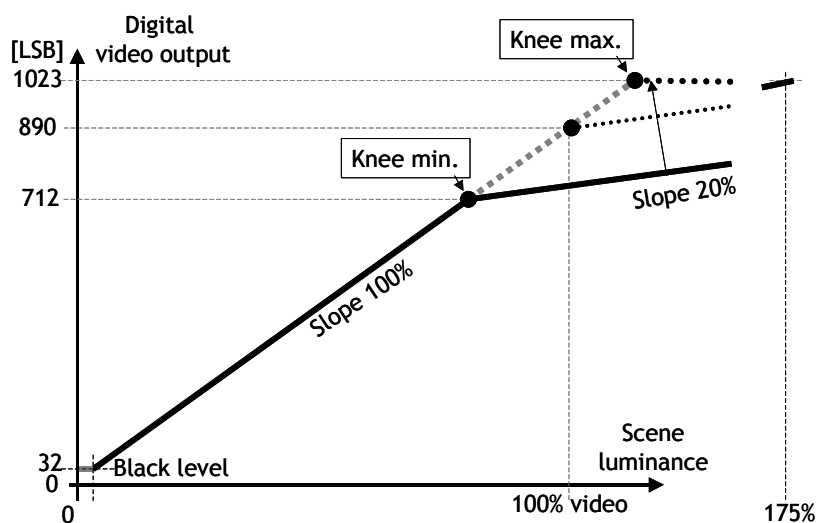

Fig. 14. Knee function

## 6.2. Sensor layout and timing.

### 6.2.1. CCD sensor layout

The CCD sensor layout with respect to pixels and lines as it is used in the timing and video read out is shown below.

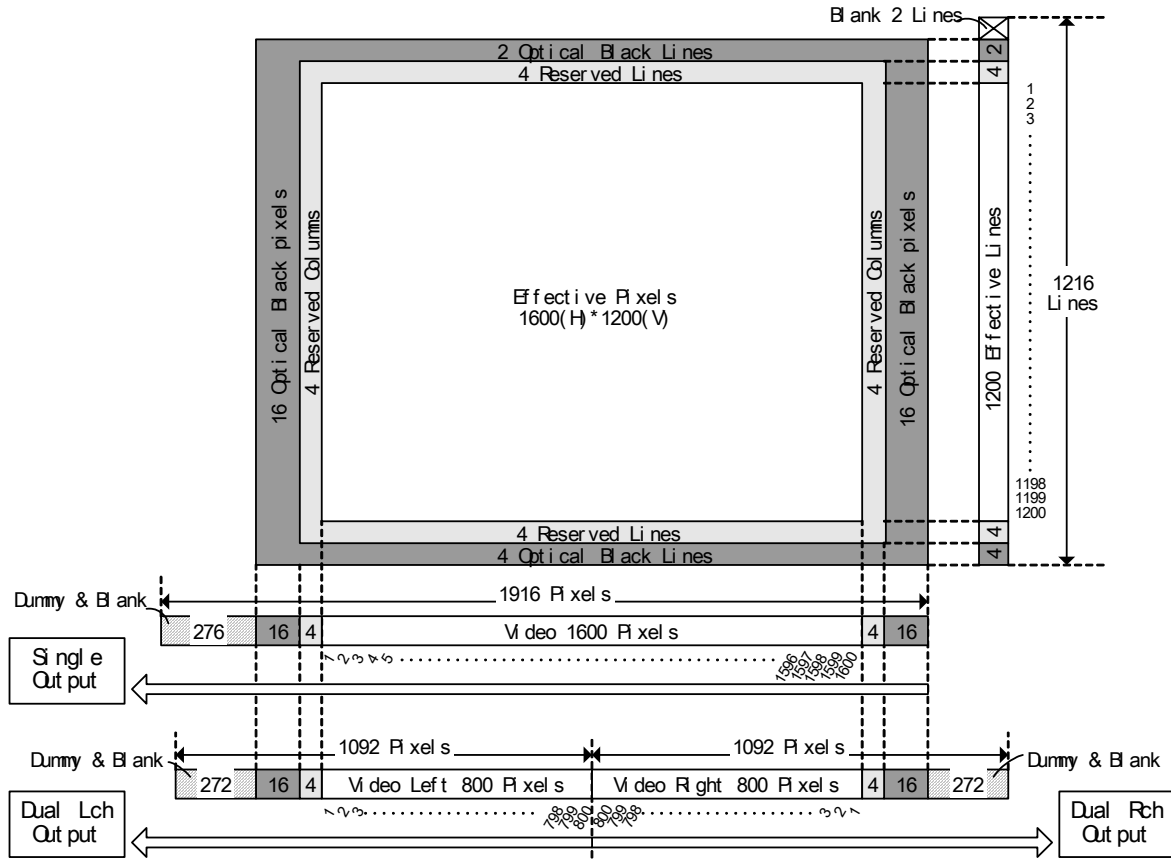

Fig. 15. CCD sensor layout

### 6.2.2. Vertical timing

Normal mode. Full frame, single and dual channel. 1LVAL = 47.9 μsec (single). 27.3 μsec (dual)

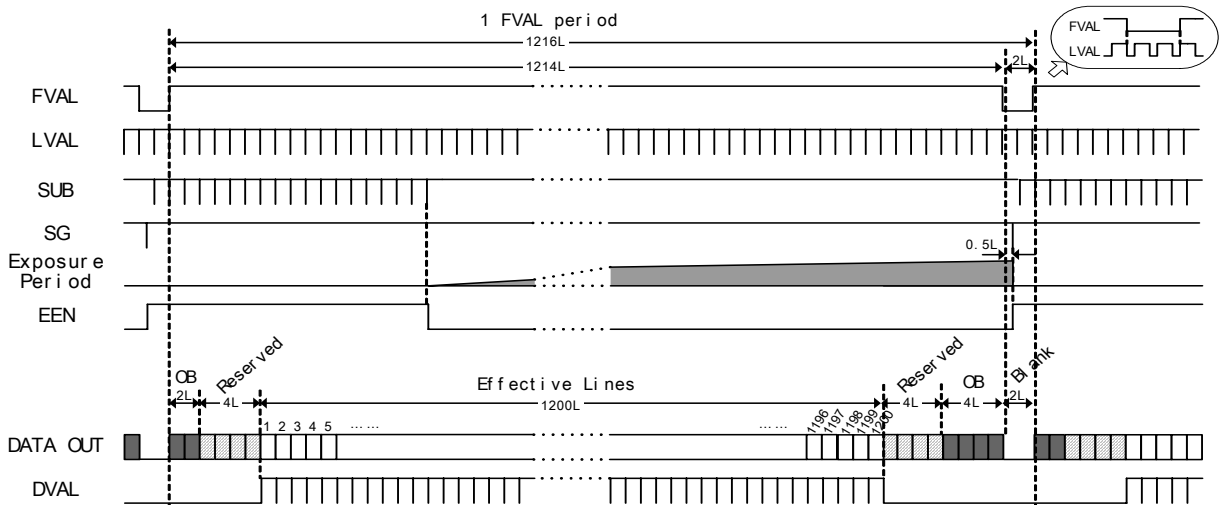

Fig. 16. Vertical timing

6.2.3. Horizontal timing single channel

OS=0. Normal mode. Full frame.

1ck = 25 nsec

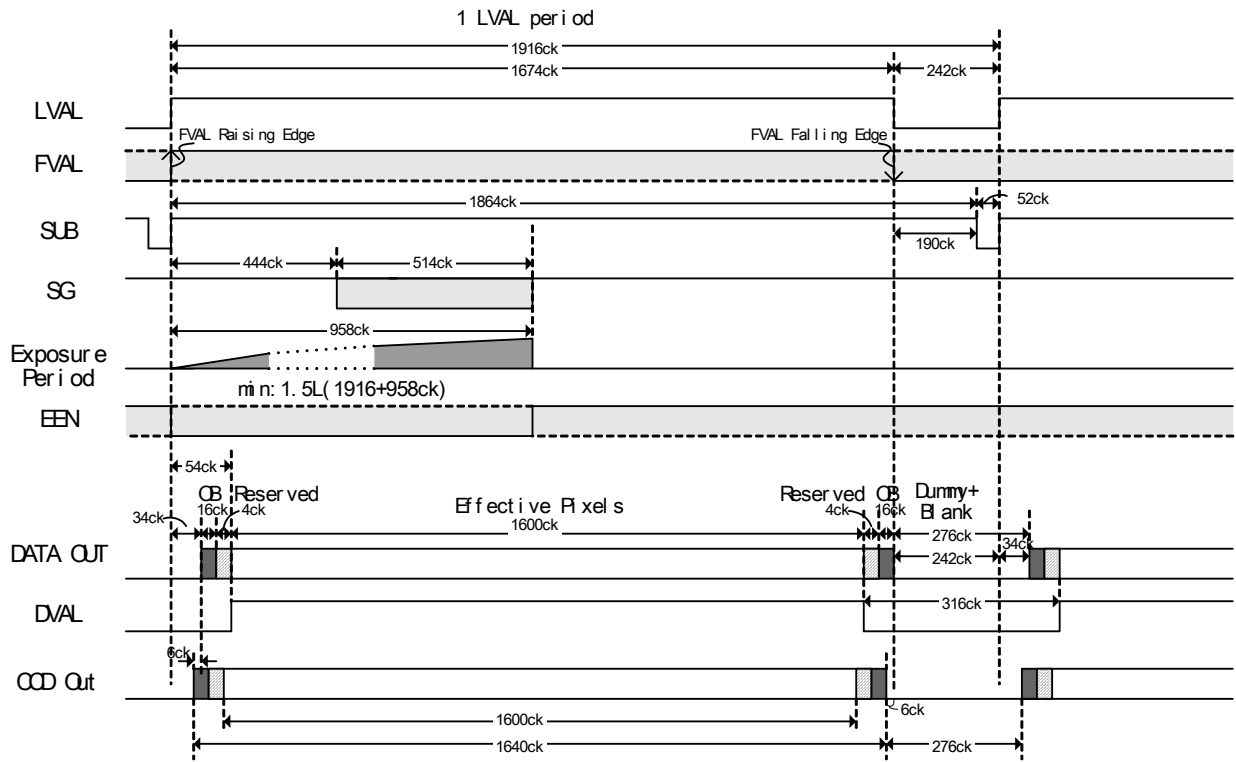

Fig. 17. Horizontal timing single channel

6.2.4. Horizontal timing details single channel

OS=0. For all modes. Full frame.

1ck = 25 nsec

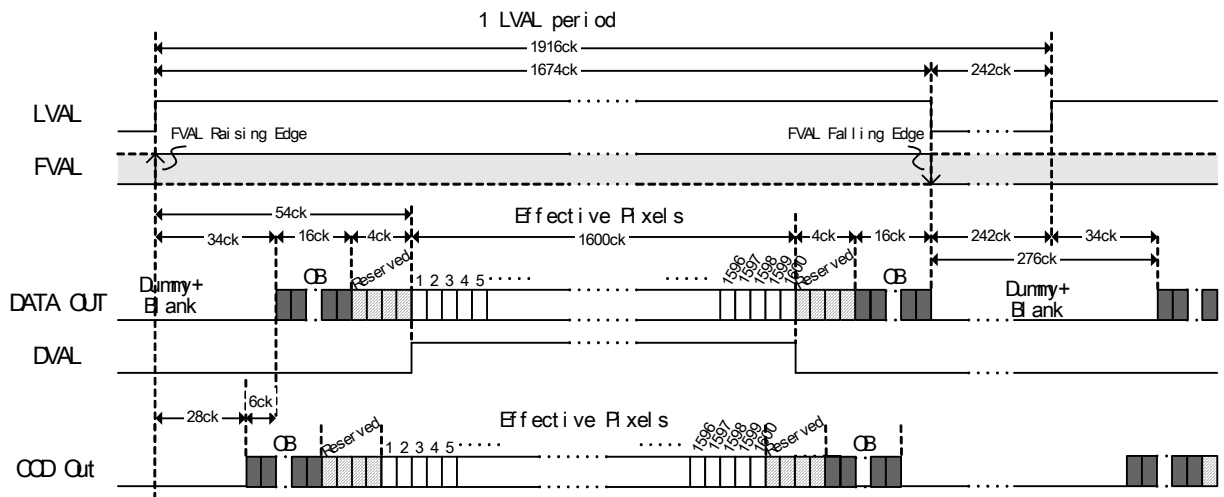

Fig. 18. Horizontal timing details single channel

6.2.5. Horizontal timing dual channel

OS=1. Normal mode. Full frame.

1ck = 25 nsec

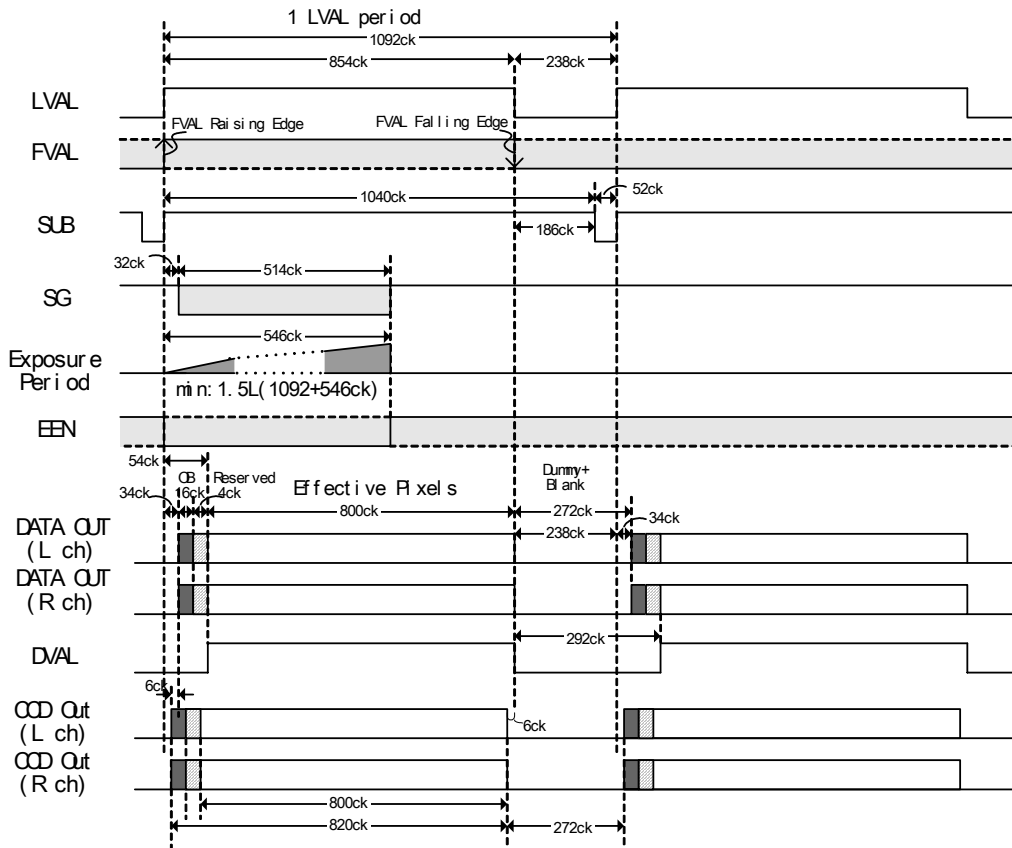

Fig. 19. Horizontal timing dual channel

6.2.6. Horizontal timing details dual channel

OS=1. For all modes. Full frame.

1ck = 25 nsec

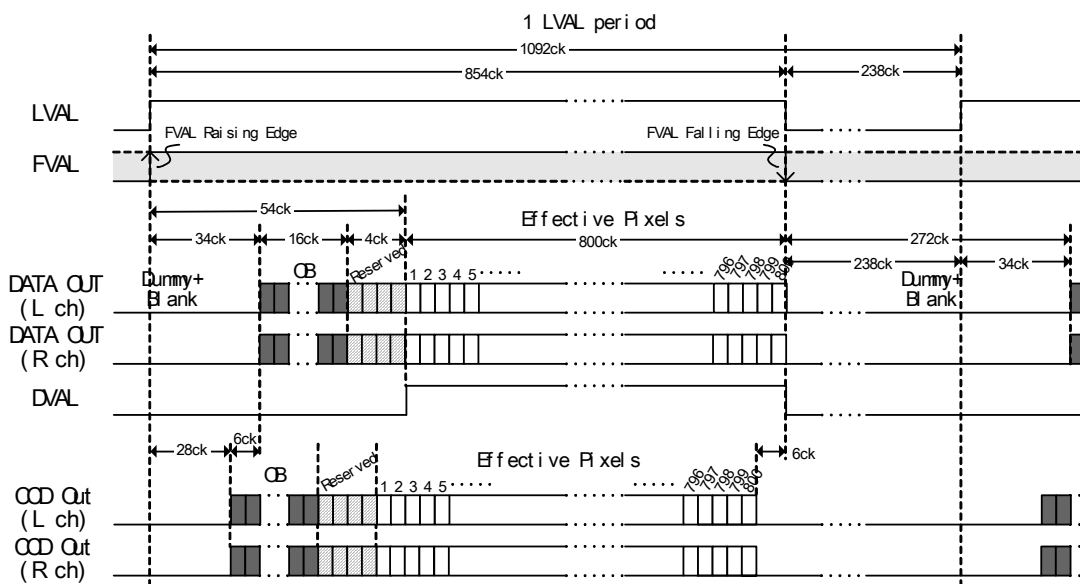

Fig. 20. Horizontal timing details dual channel

6.2.7. LVAL synchronous accumulation

With LS=0, the accumulation will start synchronously with LVAL. The trigger pulse should be longer than 2 LVAL intervals, and the accumulation will then start at the first LVAL after the trigger leading edge. The exposure start delay will be up to 1 line. (Single channel 47.9 μsec. Dual 27.3 μsec).

In EPS mode the exposure stops 0.5 L after the selected shutter time, (in number of LVAL).

In PWC mode the exposure stops 0.5 L after the first LVAL after the trigger trailing edge. It results in up to 1 LVAL jitter.

*In LVAL synchronous accumulation mode a new trigger can start a new exposure during the previous frame read out, but the exposure may not be finished before the frame is read out. It makes it possible to have a trigger rate close to the frame rate. (1 FVAL + 3 LVAL).*

**Important notes on using this mode.**

In LVAL synchronous PWC mode exposure jitter up to 1 LVAL can be the result, if the trigger trailing edge is not synchronized to LVAL.

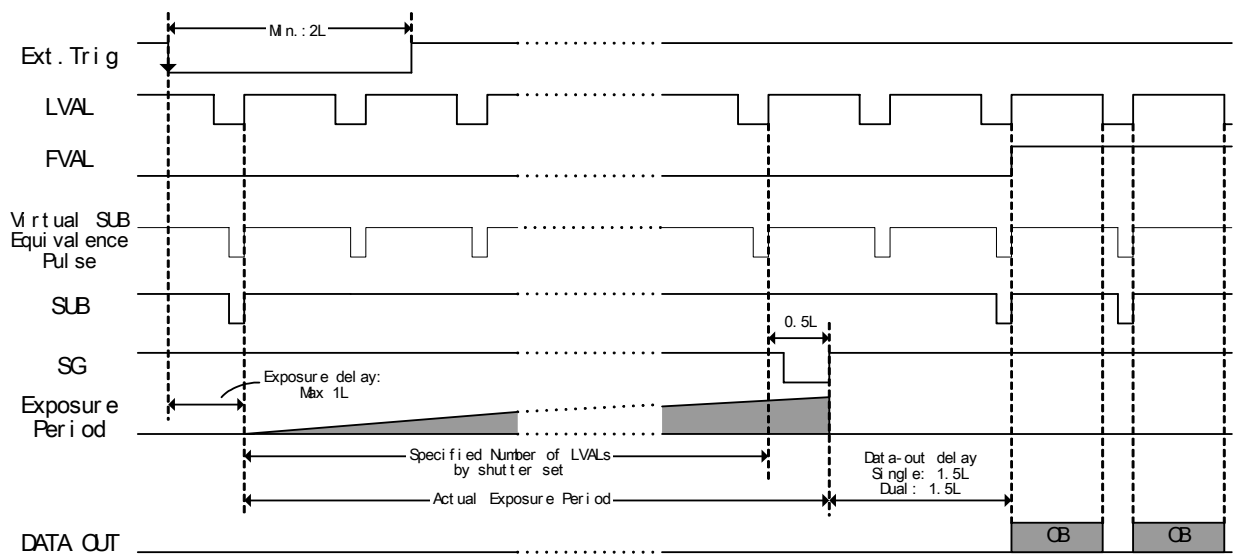

Fig. 21. LVAL synchronous accumulation in EPS mode

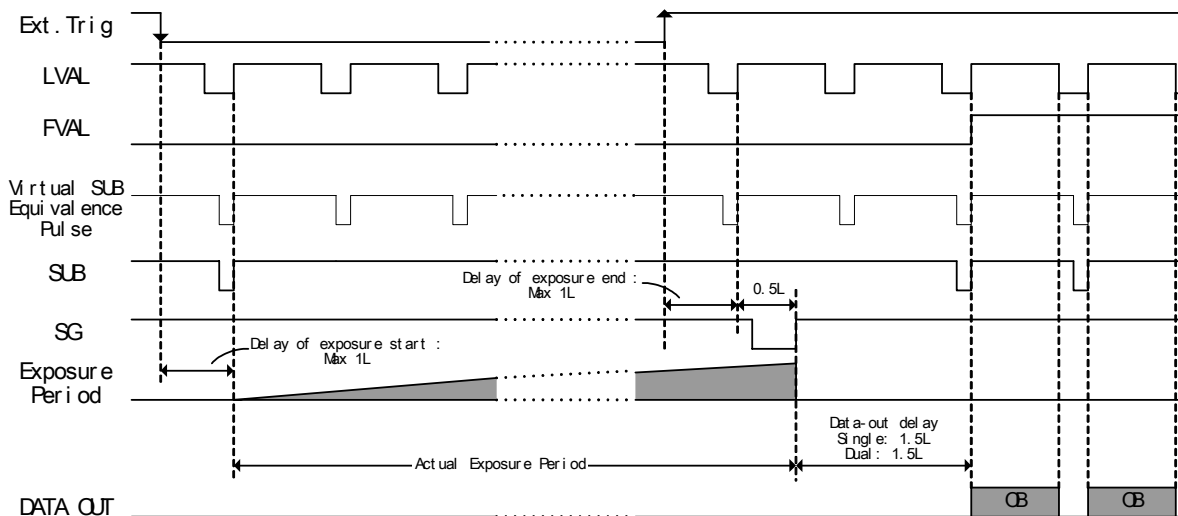

Fig. 21A. LVAL synchronous accumulation in PWC mode

6.2.8. LVAL a-synchronous accumulation

With LS=1, the accumulation will start immediately after the trigger leading edge. The exposure start delay will be 156 clk. pulses after the trigger. It is 3.9  $\mu$ sec. In EPS mode the exposure stops 0.5 L after the selected shutter time, (in number of LVAL). In PWC mode the exposure stops 0.5 L after the trigger trailing edge. A new trigger must not be applied before the previous frame is read out. (FVAL is low). The minimum trigger interval should be longer than the exposure time + 1 FVAL+3 LVAL.

**Important notes on using this mode.**

In LVAL a-synchronous PWC mode there is no exposure jitter.

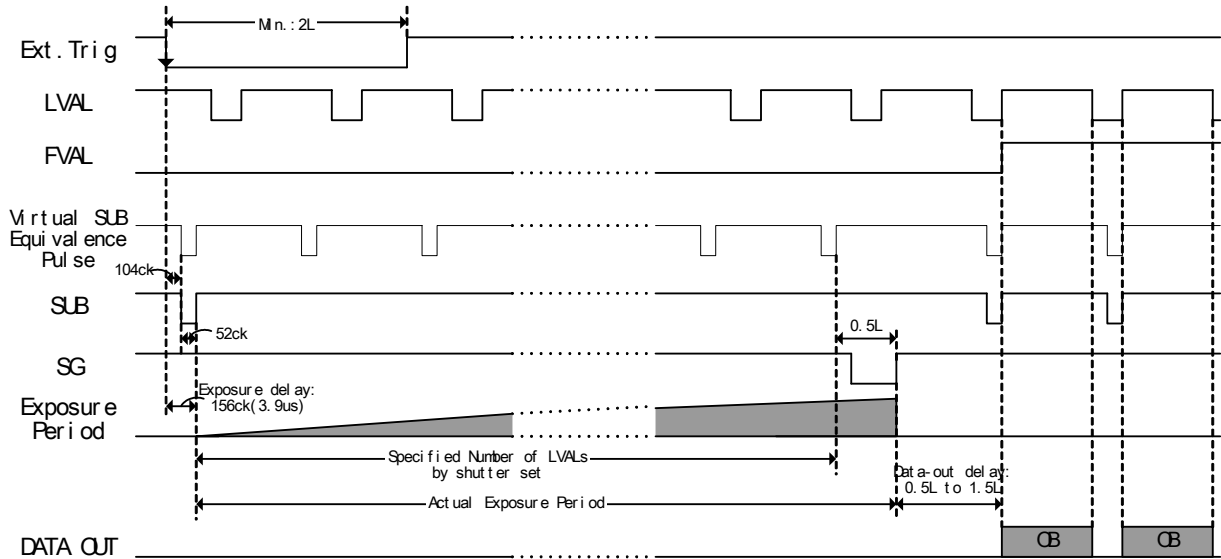

Fig. 22. LVAL a-synchronous accumulation in EPS mode

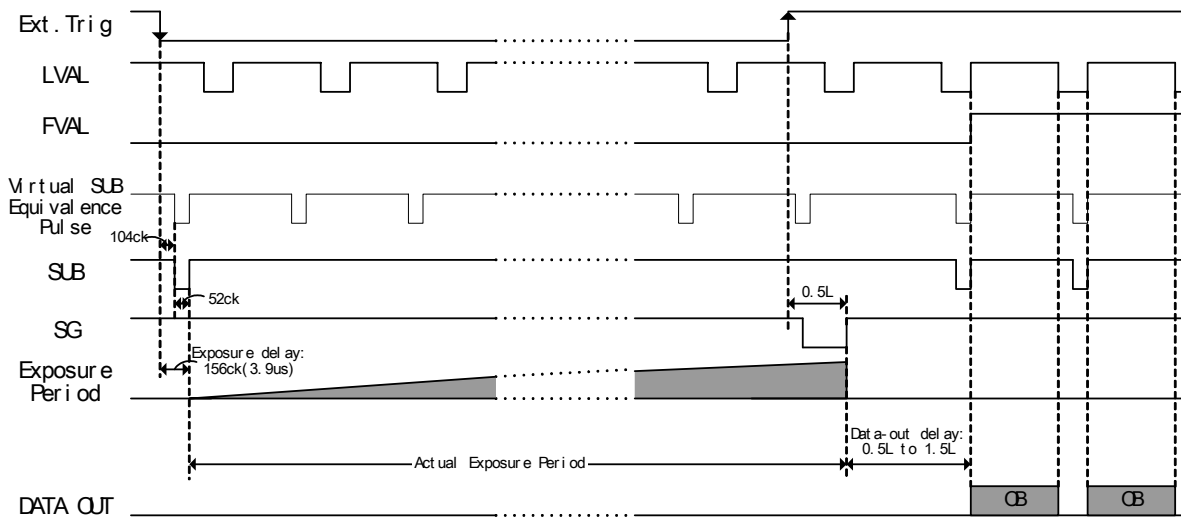

Fig. 22A. LVAL a-synchronous accumulation in PWC mode



### 6.2.9. Partial scanning vertical timing

Partial scanning has 3 pre-selected vertical centred areas 1/2, 1/4 and 1/8. SC=1 through SC=3. With SC=3, the start and the height of the partial scanned area can be programmed with 1 line interval. The start line can be programmed with PS=1 through 1151. The scanned height can be programmed with PC=50 through 1200. Partial scanning will operate with single or dual channel output. Partial scan is done by a high-speed dump read out of the areas over and under the area of interest. This partial scanned area is read out with normal speed. The high-speed dump read out (Front of Frame and in Back of Frame) is done with a speed 18 times faster for single channel, and 10 times faster for dual channel.

The figures on the timing diagram below are for 1/2 partial scanning.

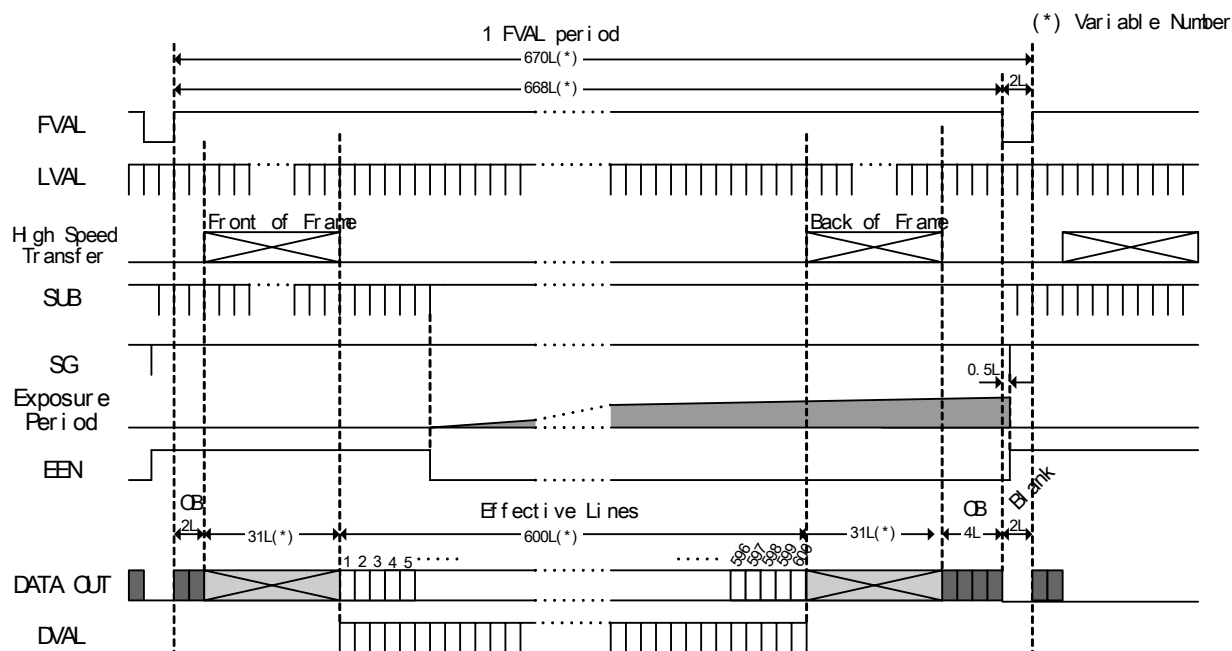

All figures marked with (\*) will change with other partial settings. See table below. 1LVAL = 47.9 μsec (single). 27.3 μsec (dual).

Fig. 23. Partial scanning vertical timing

The following table shows the figures for partial scanning.

The maximum frame rate (FPS) for single and dual channel readout is shown for normal mode. TR=0. For triggered modes it will be lower, because the accumulation time is added to the read out time. 1LVAL = 47.9 μsec (single). 27.3 μsec (dual).

Table showing values for the vertical timing.

Single channel output		Start line	Stop line	Frame Start		Effect. video [LVAL]	Frame End		Frame rate [FPS]	Remarks
Mode	Scanning			OB [LVAL]	HS [LVAL]		HS [LVAL]	OB [LVAL]		
SC=0	Full	1	1200	6	0	1200	0	10	17.17	Full scan
SC=1	1/2 partial	301	900	2	17	600	17	6	32.52	Vertical centred
SC=2	1/4 partial	451	750	2	26	300	26	6	57.99	Vertical centred
SC=3	1/8 partial	526	675	2	30	150	30	6	95.77	Vertical centred
SC=4	Programmable	1-1151	50-1200	2	-	50-1200	-	6	-	Start & height program.

Dual channel output		Start line	Stop line	Frame Start		Effect. video [LVAL]	Frame End		Frame rate [FPS]	Remarks
Mode	Scanning			OB [LVAL]	HS [LVAL]		HS [LVAL]	OB [LVAL]		
SC=0	Full	1	1200	6	0	1200	0	10	30.12	Full scan
SC=1	1/2 partial	301	900	2	31	600	31	6	54.67	Vertical centred
SC=2	1/4 partial	451	750	2	46	300	46	6	91.58	Vertical centred
SC=3	1/8 partial	526	675	2	53	150	53	6	138.75	Vertical centred
SC=4	Programmable	1-1151	50-1200	2	-	50-1200	-	6	-	Start & height program.

OB = Optical Black. HS = High-Speed dump read out.

### 6.3. Input/Output of Timing Signals

#### 6.3.1. Input of Timing Signals

It is not possible to synchronize the camera from an external sync source except by an external trigger pulse. The camera will always run with its internal X-tal controlled timing.

Trigger input through Camera Link.	TI=0
Trigger input as TTL on pin #10 on 12 pin Hirose.	TI=1
The trigger polarity is active low.	TP=0
Trigger input can be changed to active high.	TP=1

#### 6.3.2. Output of Timing Signals

To synchronize the video data transfer from the camera the following signals are available in a base configuration of Camera Link:

FVAL	Frame valid	High for valid Frame
LVAL	Line valid	High for valid line
PCLK	Pixel clock	Rising for data strobe
DVAL	Data valid	High for valid data
EEN	Exposure enable	Low during exposure. (Not specified by CL).

See the full connector pin assignment for Camera Link in chapter 5.3 and 5.4.5

For complete documentation on the Camera Link standard, please contact your JAI distributor. EEN is also found as a TTL signal on pin #9 on the 12 pin Hirose. EEN is low during exposure.

### 6.4. Trigger Modes

This camera can operate in 6 primary modes. 1 non-triggered mode and 5 external trigger modes, which can be set by RS-232C commands.

- |    |  |   |
|----|--|---|
| 1. | <i>Normal continuous Mode. TR=0</i>          | Pre-selected exposure. (SM=0, SM=1)     |
| 2. | <i>Edge Pre-select Mode. TR=1</i>            | Pre-selected exposure. (SM=0, SM=1)     |
| 3. | <i>Restart Continuous Trigger Mode. TR=2</i> | Pre-selected exposure. (SM=0, SM=1)     |
| 4. | <i>Pulse Width Control Mode. TR=3</i>        | Pulse width controlled exposure.        |
| 5. | <i>Burst Trigger mode Mode. TR=4</i>         | 5 EPS. Read out by trailing trig. edge. |
| 6. | <i>PIV Mode. TR=5</i>                        |   |

In normal continuous mode and edge pre-select mode the shutter time can be selected from the normal 10 fixed steps. (SM=0). Or it can be selected from the 1216 steps programmable (SM=1). Pulse width control can be used for long time exposure. The trigger pulse width can be from 2 LVAL to  $\infty$ . The exposure time is not recommended to exceed 2 seconds.

Partial scan (SC=0 through 3) can be used in all 6 modes.

#### **Important note on changing trigger modes by RS-232C and CL.**

*Disconnect or stop the trigger input before changing mode by RS-232C or Camera Link. In worst case it can lead to latch-up of camera function and communication if a mode command is received at same time as a trigger pulse. The modes are trigger modes (TR) and scanning (SC). The camera latch-up can only be reset if the power is switched off and on again.*

### 6.4.1. Continuous Operation (Non triggered)

Mode settings can be done with RS-232C. Trigger Mode Normal. TR=0. It is for applications where the camera is continuously running without external trigger. The shutter mode can be normal or programmable exposure. (SM=0, SM=1). The shutter will work in all 10 steps up to 1/14,000 second or with the programmable exposure in 1216 steps. In partial scanning, shutter times longer than the actual frame time has no meaning. The exposure will be equal the frame time. In this mode it is possible to have CCIR/EIA composite analogue video output for monitor use. It is for full scan only. The video can be 50 or 60 frames per second with a line frequency at 15.734 kHz. CCIR has 290 active lines. Shutter speed <313 LVAL. EIA has 240 active lines. Shutter speed <263 LVAL.

To use this mode:

Set function:	Trigger mode "Normal"	TR=0
	Shutter mode "Normal" or "Programmable"	SM=0, SM=1
	"Shutter Speed"	SH=0 through 9
	"Programmable exposure"	PE=1 through 1216
	Scanning format	SC=0 through SC=4
	Output select	OS=0, OS=1, OS=2
	Polarity and other functions	

#### **Important notes on using this mode.**

- Analogue video output OS=2 only for full SC=0

For vertical timing refer to 6.2.2. (Fig. 16.)

For horizontal timing refer to 6.2.3 through 6.2.6. (Fig.17. through fig. 20.)

### 6.4.2. Edge Pre-select Mode

In EPS mode, the trigger leading edge will start an exposure at the first LVAL pulse if LS=0, (or immediately if LS=1), and it stops and the resulting image is read out after the pre-selected shutter time. It can be the 10 steps in normal or 1216 steps in programmable. SM=0 or SM=1. This mode will operate with full and partial scanning.

An EEN pulse will indicate the active accumulation time, and a FVAL pulse indicates that the resulting video is read out.

To use this mode:

Set function:	Trigger mode "Edge Pre-select"	TR=1
	LVAL synchronous accumulation	LS=0, LS=1
	Shutter mode "Normal" or "Programmable"	SM=0, SM=1
	"Shutter Speed"	SH=0 through 9
	"Programmable exposure"	PE=1 through 1216
	Scanning format	SC=0 through SC=4
	Output select	OS=0, OS=1
	Polarity and other functions	
Input:	Ext. trigger to Camera Link or pin 10 on 12-pin connector.	

#### Important notes on using this mode.

- The duration of the trigger should be  $>2LVAL$  to  $<3FVAL$ .
- If LS=0 (Synchronous accumulation), the minimum trigger interval is 1 FVAL + 3 LVAL. The new exposure should not be finish before the previous frame is read out.
- If LS=1 (Asynchronous accumulation) the minimum trigger interval is the exposure time + 3 LVAL. A new trigger must not be applied before FVAL is low.
- 1LVAL = 47.9  $\mu$ sec (single). 27.3  $\mu$ sec (dual).

For horizontal timing refer to 6.2.3 through 6.2.6. (Fig.17. through fig. 20.)

For LVAL synchronous accumulation refer to 6.2.7 and 6.2.8. (Fig. 21. fig. 22.)

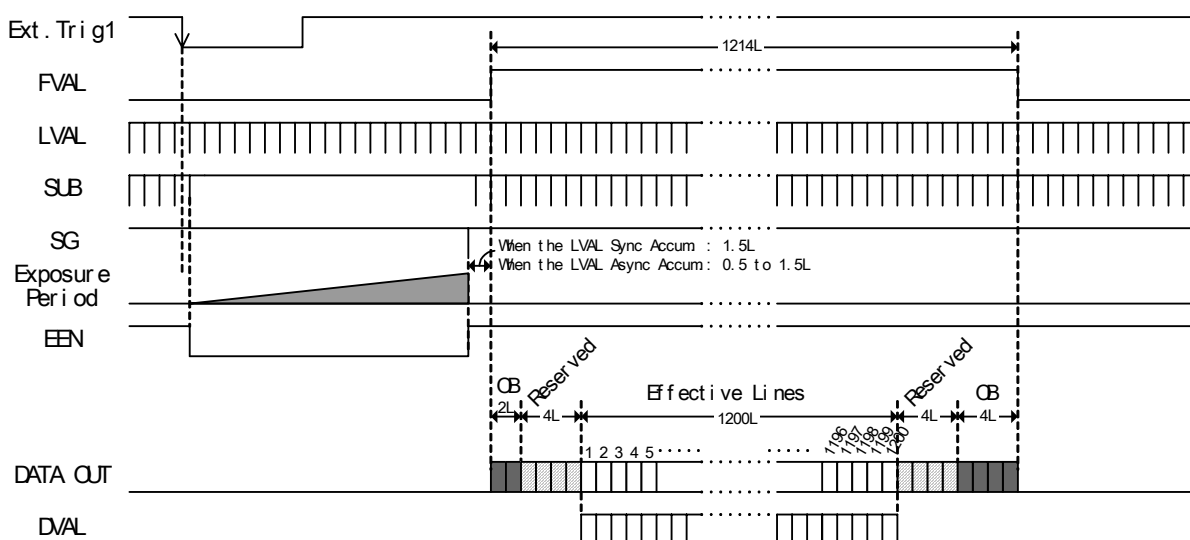

Fig.24. Edge Pre-select mode vertical timing

### 6.4.3. Restart Continuous Trigger mode

The RCT mode is in principle the same as normal continuous mode. The difference is that an external trigger pulse will immediately stop the video read out and reset and restart the vertical timing. After a fast dump read out, a new triggered exposure is started and read out as normal. The fast dump read out is performed with a speed 18 times faster for single output, and 10 times faster for dual output. If no further trigger pulses are applied, the camera will continue in normal mode. This fast dump read out has the same effect as "smearless read out". Smear over highlighted areas are reduced for the triggered frame.

The restart continuous trigger mode makes it possible to use a lens with video controlled iris in intelligent traffic surveillance applications.

To use this mode:

Set function:	Trigger mode "Restart continuous trigger"	TR=2
	LVAL synchronous accumulation	LS=0
	Shutter mode "Normal" or "Programmable"	SM=0, SM=1
	"Shutter Speed"	SH=0 through 9
	"Programmable exposure"	PE=1 through 1216
	Scanning format	SC=0 through SC=4
	Output select	OS=0, OS=1
	Polarity and other functions	
Input:	Ext. trigger to Camera Link or pin 10 on 12-pin connector.	

#### Important notes on using this mode.

- The duration of the trigger should be  $>2LVAL$  to  $<3FVAL$ .
- A new trigger must not be applied before the triggered data is read out.
- $1LVAL = 47.9 \mu\text{sec}$  (single).  $27.3 \mu\text{sec}$  (dual).
- The time for the fast dump read out (smearless) is 3.3 msec.

For horizontal timing refer to 6.2.3. through 6.2.6. (Fig.17. through fig. 20.)

For LVAL synchronous accumulation refer to 6.2.7. and 6.2.8. (Fig. 21. fig. 22.)

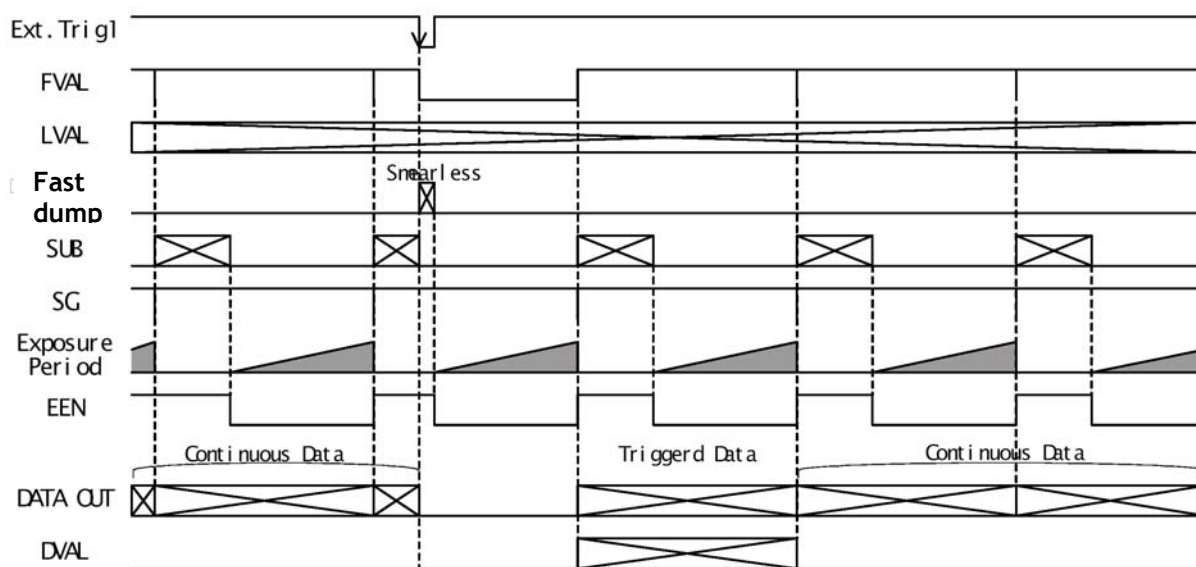

Fig. 25. Restart Continuous trigger mode

6.4.4. Pulse Width Control Mode

In PWC mode, the trigger leading edge will start an exposure at the first LVAL pulse if LS=0 (or immediately if LS=1). It stops at the trailing edge of the trigger pulse, and the resulting video is read out. This mode will operate with full and partial scanning. An EEN pulse will indicate the active accumulation time, and a FVAL pulse indicates that the resulting video is read out. Long time exposure can be done with pulse width control mode.

To use this mode:

Set function:	Trigger mode "Pulse width control"	TR=3
	LVAL synchronous accumulation	LS=0, LS=1
	Scanning format	SC=0 through SC=4
	Output select	OS=0, OS=1
	Polarity and other functions	
Input:	Ext. trigger to Camera Link or pin 10 on 12-pin connector.	

**Important notes on using this mode.**

- The duration of the trigger can be  $>2LVAL$  to  $\infty$ . Thermal noise and dark current noise will increase by accumulation time, therefore the exposure time is not recommended to exceed 2 seconds.
- If LS=0 (Synchronous accumulation), the minimum trigger interval is 1 FVAL + 3 LVAL. The new exposure should not be finished before the previous frame is read out.
- If LS=1 (Asynchronous accumulation) the minimum trigger interval is the exposure time + 3 LVAL. A new trigger must not be applied before FVAL is low.
- 1LVAL = 47.9  $\mu$ sec (single). 27.3  $\mu$ sec (dual).

For horizontal timing refer to 6.2.3. through 6.2.6. (Fig.17. through fig. 20.)

For LVAL synchronous accumulation refer to 6.2.7 and 6.2.8. (Fig. 21. fig. 22.)

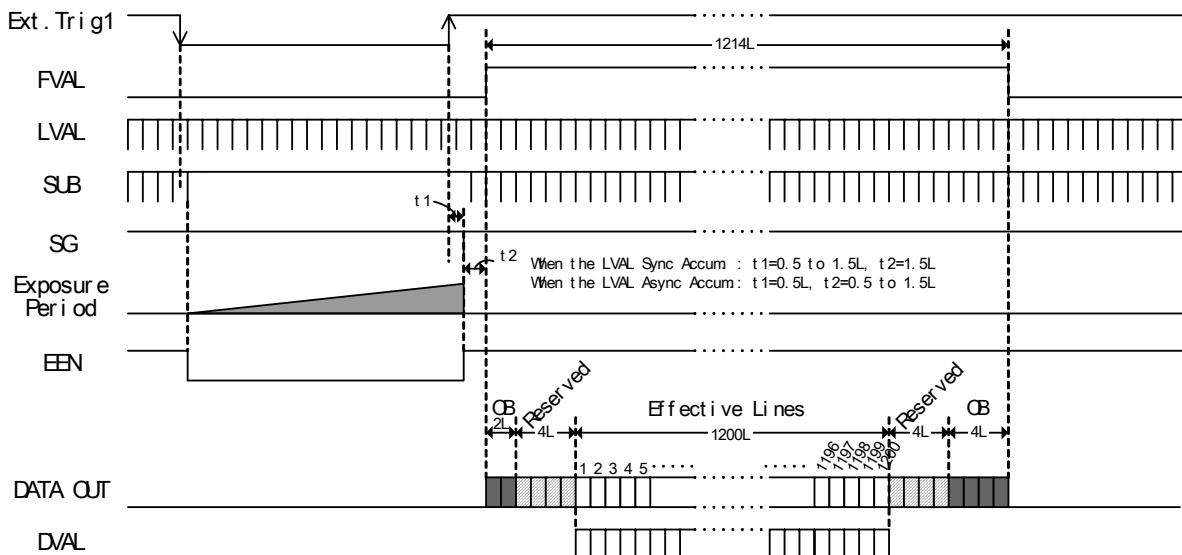

Fig. 26. Pulse Width Control mode vertical timing

### 6.4.5. Burst Trigger mode

With the burst trigger function, a single trigger pulse can start a sequence with five previous set pre-selected programmable exposures. The five shutter times can be set with BSH1 through BSH5. (Exposure 1H through 1216H.) The exposure is LVAL synchronous.

The sequence will start with the first exposure at the first LVAL pulse after the trigger leading edge, and the result is read out after the selected shutter time. During the read out of the previous frame, the next exposure starts. It will continue until exposure 5 is read out.

This mode will operate with full and partial scanning.

An EEN pulse will indicate the active accumulation time, and a FVAL pulse indicates that the resulting video sequence is read out.

To use this mode:

Set function:	Trigger mode "Burst EPS"	TR=4
	LVAL synchronous accumulation	LS=0
	Burst Shutter 1	BSH1=1 through 1216
	Burst Shutter 2	BSH2=1 through 1216
	Burst Shutter 3	BSH3=1 through 1216
	Burst Shutter 4	BSH4=1 through 1216
	Burst Shutter 5	BSH5=1 through 1216
	Scanning format	SC=0 through SC=4
	Output select	OS=0, OS=1
	Polarity and other functions	
Input:	Ext. trigger to Camera Link or pin 10 on 12-pin connector.	

#### Important notes on using this mode.

- The duration of the trigger should be  $>2LVAL$  to  $<3FVAL$ .
- A new trigger must not be applied before FVAL is low after frame 5.
- $1LVAL = 47.9 \mu\text{sec}$  (single).  $27.3 \mu\text{sec}$  (dual).

For horizontal timing refer to 6.2.3 through 6.2.6. (Fig.17. through fig. 20.)

For LVAL synchronous accumulation refer to 6.2.7. (Fig. 21.)

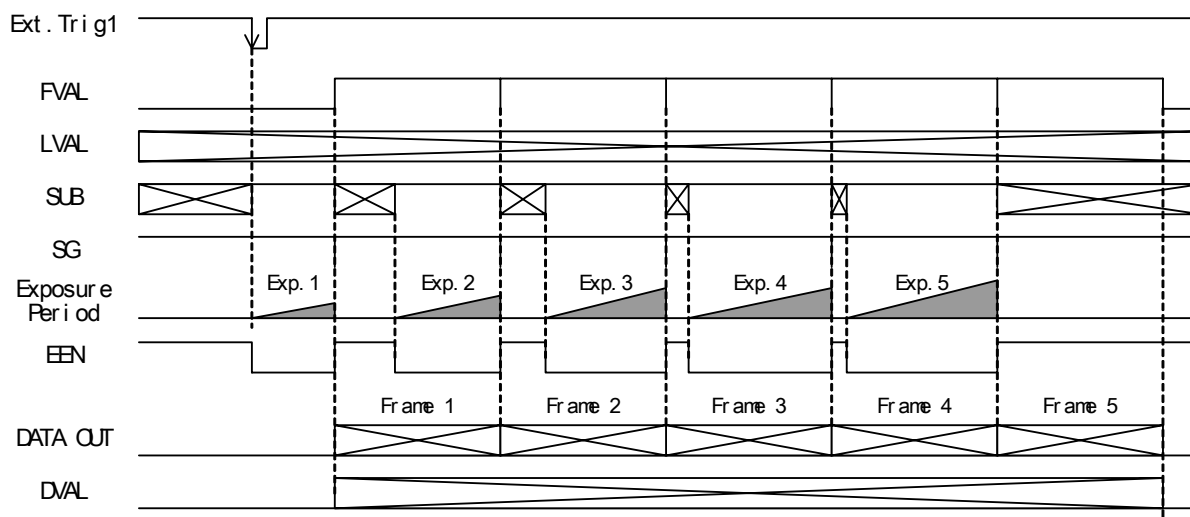

Fig. 27. Burst Trigger mode

6.4.6. PIV mode.

PIV mode (Particle Image Velocimetry) can be used in applications where 2 images should be taken with a very short time interval. It can only be used with strobe flash as illumination. The first accumulation time is fixed at 4  $\mu$ sec. After a delay  $>1.5 \mu$ sec. the second exposure period starts. It is as long as the time for a full frame. The accumulation is LVAL a-synchronous. The first exposure period starts at the trigger leading edge. The first strobe flash should be fired within the first exposure period, and the second strobe flash during the first frame read out period. The result will then be 2 frames exposed with the flash interval.

To use this mode:

Set function:	Trigger mode "PIV"	TR=5
	LVAL synchronous accumulation	LS=1
	Scanning format	SC=0 through SC=4
	Output select	OS=0, OS=1
	Polarity and other functions	
Input:	Ext. trigger to Camera Link or pin 10 on 12-pin connector.	
	2 strobe flash	

**Important notes on using this mode.**

- The duration of the trigger should be  $>2LVAL$  to  $<3FVAL$ .
- A new trigger must not be applied before FVAL is low after second frame readout.
- $1LVAL = 47.9 \mu$ sec (single).  $27.3 \mu$ sec (dual).

For horizontal timing refer to 6.2.3. through 6.2.6. (Fig.17. through fig. 20.)

For LVAL a-synchronous accumulation refer to 6.2.8. (fig. 22.)

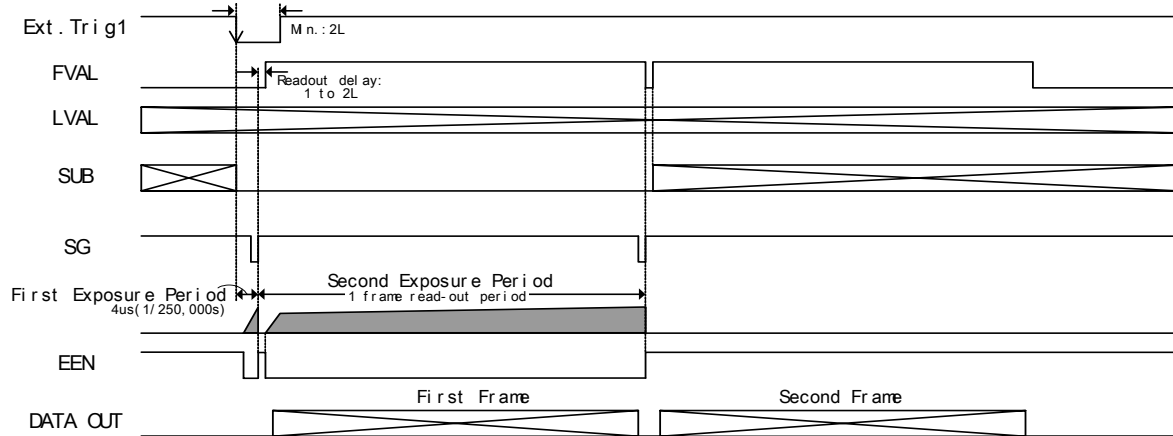

Fig. 28. PIV mode

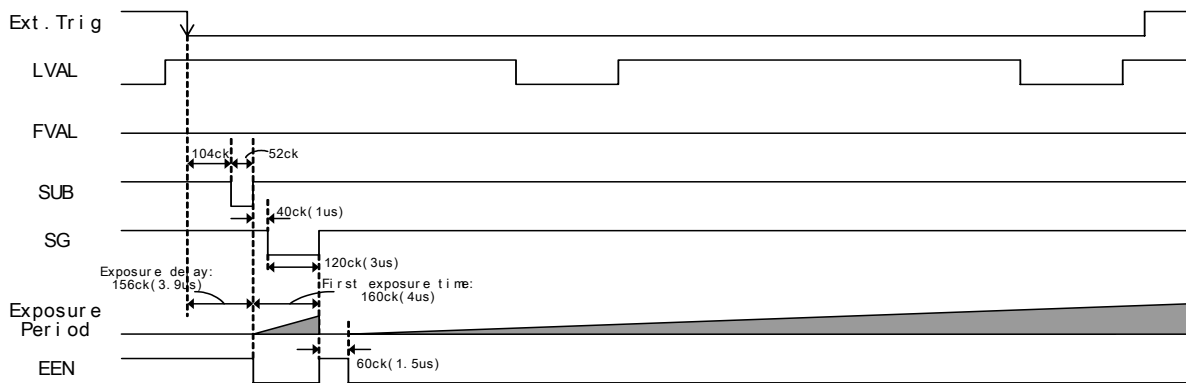

Fig. 28A. PIV mode details



### 6.4.7. Sensor Gate Control

This function is for applications with strobe flash illuminations or long time accumulations up to several frames. The resulting video is then read out after the first FVAL (or SG), following the trailing edge of the Sensor Gate Control signal.

The sensor gate control signal can be synchronized by the FVAL signal. Fig. 29A. and fig. 29B. shows the minimum sensor gate signal width if it is synchronized to FVAL.

To use this mode:

Set function:	Trigger mode "Normal"	TR=0
	Sensor gate control	SG=1
	LVAL synchronous accumulation	LS=1
	Scanning format	SC=0 through SC=4
	Output select	OS=0, OS=1
	Polarity and other functions	

Input: Sensor gate control to Camera Link or pin 10 on 12-pin connector.

**Important notes on using this mode.**

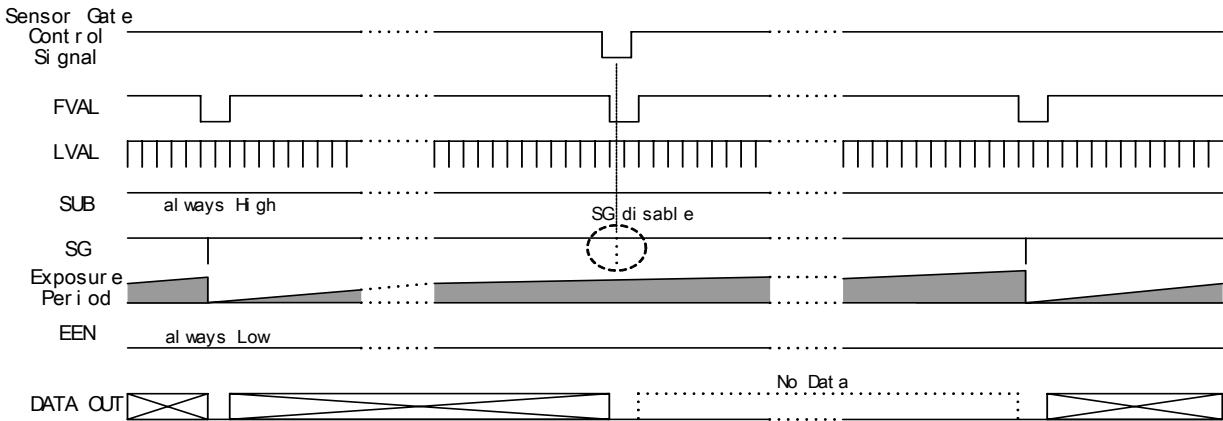

Fig. 29. Sensor Gate Control

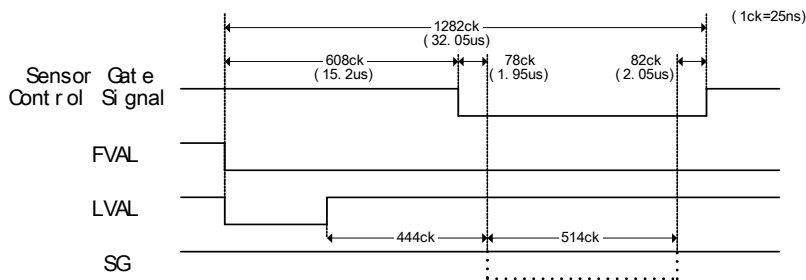

Fig. 29A. Sensor Gate Control single channel details

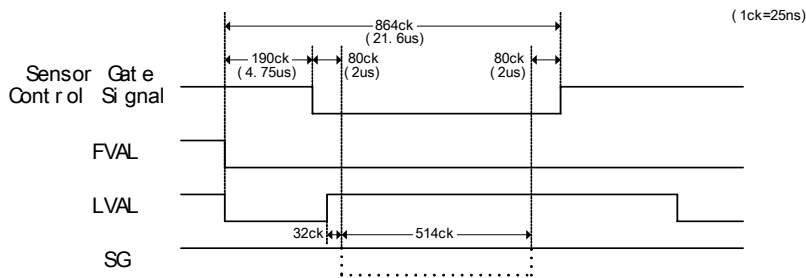

Fig. 29B. Sensor Gate Control dual channel details

### 6.5. Other Functions.

The following functions are described under their short ASCII command name.

**BA: Output bit allocation**

With this function the number of bits in the Camera Link video output can be selected to 10 or 8. If 8 bit is selected it is the 8 most significant bits. For the bit allocation in Camera Link output, please refer to "5.4.5. Camera Link interface" and to fig. 7.

**MN: Monitor mode**

In normal mode (TR=0) and full frame (SC=0) the output command (OS=2) selects the composite analogue monitor video system. MN=1 for CCIR (50 FPS, 313 lines, 290 active lines). MN=0 for EIA (60 FPS, 263 lines, 240 active lines). The line frequency is 15.734 kHz. The video can be seen on a standard monitor with the command OS=2. SW1.1 can also be used. SW1.1 has highest priority.

**TI: Trigger input select**

To select the trigger input via Camera Link or pin #10 on Hirose connector as a TTL signal. The trigger input can also be selected by the internal switch, which has highest priority.

**TP: Trigger polarity**

This command can change the trigger polarity.

**GS: Gamma select**

To select gamma 1 or 0.45. 1 is linear relation between scene luminance and video output. 0.45 will expand the contrast in dark and compress the contrast in light parts of the scene.

**RP: Rear pot**

Select master gain from the potentiometer or RS-232C. Sw1.4 has highest priority.

**AU: Auto dual adjust**

This function is used to calibrate the 2 channels to have same black level and gain. ABA (Automatic Black Adjust) is a one-push function to align the black level for the 2 channels. AWA (Automatic White Adjust) is a one-push function to align the white level for the 2 channels.

**BL: Black level master**

**BLF: Black level fine. Right**

To adjust the black level for both channels and to fine adjust the R channel.

**GA: Gain level master**

**GLR: gain level fine. Right**

To adjust the gain for both channels and to fine adjust the R channel.

**KL: Knee point master**

**KNF: Knee point fine. Right**

To adjust the Knee point for both channels and to fine adjust the R channel.

**Important notes on using this functions.**

Adjusting the gain and black level settings should only be done when the camera is on its operation temperature. >30 minutes after power on.

## 7. Configuring the Camera

### 7.1. Mode setting SW1 on rear

Switch SW 1.1 on the camera rear can be used to select digital or analogue video out. SW1.1 has higher priority than RS-232C.

SW1.2 is for termination of the trigger 1 input on pin #10 Hirose.

(SW1.3 is for termination of the factory test input on pin #11 Hirose)

SW1.4 is for master gain selection. SW1.4 has higher priority than RS-232C.

Fine gain adjustment on R channel by RS-232C.

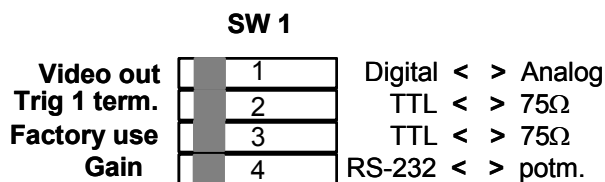

Fig. 30. SW1 on camera rear

### 7.2. RS-232C/Camera Link switch

The internal switch HR/CL can be used to select the control input via the 12 pin Hirose as RS-232C or via Camera Link. Factory setting is Camera Link. The switch is placed inside the camera on the motherboard.



Fig. 31. Internal Switch

### 7.3. Internal Switch

The switch is placed inside the camera on the motherboard.

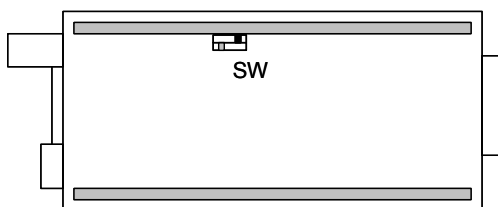

Fig. 32. Internal switch

### 7.4. RS-232C control

All configuration of the CV-M2 camera is done via the RS-232C port on the 12 pin HR connector or via Camera Link. The control mode can be selected by the internal switch RS-232C/Camera Link. The camera can be set up from a PC running terminal emulator software, or using JAI's camera control software.

Below is the description of the ASCII based short command protocol.

#### Communication setting.

Baud Rate	9600 bps
Data Length	8 bit
Start Bit	1 bit
Stop Bit	1 bit
Parity	None
Xon/Xoff Control	None

RS 232C cable

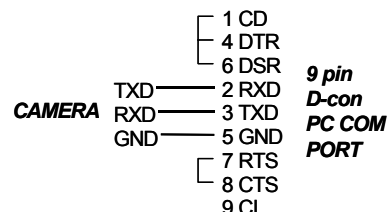

#### Protocol.

Transmit setting to camera:

**NN=[Parameter]<CR><LF>** (NN is any kind of command. Capital or small letters.)

The camera answers:

**COMPLETE<CR><LF>**

To have all communication visible on the emulator screen, start with:

**EB=1<CR><LF>**

The camera answers:

**COMPLETE<CR><LF>**

Transmit request command to camera:

**NN?<CR><LF>** (NN is any kind of command.)

The camera answers:

**NN=[Parameter]<CR><LF>**

Transmit the following to have the camera actual setting:

**ST?<CR><LF>**

The camera answers:

A complete list of the current settings

Transmit the following to have a command list:

**HP?<CR><LF>**

The camera answers:

A list with all commands and possible settings

Invalid parameters send to camera: (99 is an invalid parameter)

**SH=99<CR><LF>**

The camera answers:

**02 Bad Parameters!!<CR><LF>**

To see the firmware number.

**VN?<CR><LF>**

To see the camera ID. It shows the manufacturing lot.

**ID?<CR><LF>**

7.5. CV-M2 command list

Command Name	Format	Parameter	Remarks
<b>A - General settings and useful commands</b>			
EB	Echo Back	EB=[Param.]<CR><LF>	0=Echo off      1=Echo on Off at power up
ST	Camera Status request	ST?<CR><LF>	Actual setting
HP	Online Help request	HP?<CR><LF>	Command list
VN	Firmware version	VN?<CR><LF>	3 letter version
ID	Camera ID request	ID?<CR><LF>	10 Characters
MD	Model Name request	MD?<CR><LF>	≤10 Characters
UD	User ID	UD=[Param.]<CR><LF>	User text ≤16 Characters For user ID data
<b>B - Video Output</b>			
OS	Output select	OS=[Param.]<CR><LF>	0=single chan.      1=dual chan. 2=monitor 1-2 Camera Link 3 Analog in BNC
BA	Output bit allocation	BA=[Param.]<CR><LF>	0=10 bit      1=8 bit Camera Link
MN	Monitor mode	MN=[Param.]<CR><LF>	0=EIA (60FPS)      1=CCIR (50FPS) Analog in BNC
<b>C - Timing and shutter related commands</b>			
SC	Scanning format	SC=[Param.]<CR><LF>	0=full frame      1=1/2 partial 2=1/4 partial      3=1/8 partial 4= progr. p. sc *)
PS	Progr. Par. Scan start	PS=[Param.]<CR><LF>	1-1151 Start line #
PC	Progr. Par. Scan hight	PC=[Param.]<CR><LF>	50-1200 Hight line#
TR	Trigger mode	TR=[Param.]<CR><LF>	0=normal      1=Edge pre-sel 2=Restart Cont      3=Pulse width 4=Burst EPS      5=PIV *)
SM	Shutter mode	SM=[Param.]<CR><LF>	0=Normal      1=Program. exp
SH	Shutter speed	SH=[Param.]<CR><LF>	0=Off (frame)      1=1/60 2=1/120      3=1/250 4=1/500      5=1/1000 6=1/2000      7=1/4000 8=1/8000      9=1/14,000 All10 steps are valid in normal trigger mode, EPS and RCT mode.
PE	Programmable expos.	PE=[Param.]<CR><LF>	1-1216 (1.5H to 1216.5H. single chan) 1-1216 (1.5H to 1216.5H. dual channel) H = 47.9µsec H = 27.3µsec
BSH1	EPS Burst shutter 1	BSH1=[Param.]<CR><LF>	1-1216 (As programmable shutter)
BSH2	EPS Burst shutter 2	BSH2=[Param.]<CR><LF>	
BSH3	EPS Burst shutter 3	BSH3=[Param.]<CR><LF>	
BSH4	EPS Burst shutter 4	BSH4=[Param.]<CR><LF>	
BSH5	EPS Burst shutter 5	BSH5=[Param.]<CR><LF>	
<b>D- Signals and polarity</b>			
LS	LVAL synchronous accum	LS=[Param.]<CR><LF>	0= syn. accum      1=asyn. accum
TI	Trigger Input	TI=[Param.]<CR><LF>	0= CamerLink      1= 12 pin Hirose
TP	Trigger polarity	TP=[Param.]<CR><LF>	0= active low      1= active high
SG	Sensor Gate control	SG=[Param.]<CR><LF>	0= Off      1= ON Only if TR=0
<b>E - Gain and analogue signals setting</b>			
BL	Black level master	BL=[Param.]<CR><LF>	0-1023 (0=low, 1023=high)
BLF	Black level R fine	BLF=[Param.]<CR><LF>	-512 to 511 (-512=low, 511=high)
GA	Gain level master	GA=[Param.]<CR><LF>	0-4095 (0 = low, 4095 =high) Range -4 to 14 dB
GAF	Gain level R fine	GAF=[Param.]<CR><LF>	-2048 to 2047 (-2048=low, 2047=high)
KN	Knee select	KN=[Param.]<CR><LF>	0=Off      1=ON
KL	Knee point master level	KL=[Param.]<CR><LF>	0-1023 (0=low, 1023=high)
KNF	Knee point R fine level	KNF=[Param.]<CR><LF>	-512 to 511 (-512=low, 511=high)
GS	Gamma select	GS=[Param.]<CR><LF>	0=Off ( =1)      1=ON ( =0.45) Single ch. Only
RP	Rear Potentiometer	RP=[Param.]<CR><LF>	0>manual gain      1=rear potm.
AU	Auto dual adjust	AU=[Param.]<CR><LF>	0=Off      1=ABA 2=AWA
<b>F - Saving and loading data in EEPROM</b>			
LD	Load settings from camera EEPROM	LD=[Param.]<CR><LF>	0=Factory data      1=User 1 area Latest used data at power up
SA	Save settings to camera EEPROM	SA=[Param.]<CR><LF>	1=User 1 area Parameter = 0 is not allowed
EA	EEPROM area request	EA?<CR><LF>	0=Factory data      1=User 1 area Return the latest used data area

\*) Disconnect the trigger input before changing mode by RS-232C or Camera Link.

!! Do not try to use commands or parameters not shown in this list.

### 7.6. Camera Control Tool for CV-M2

From [www.jai.com](http://www.jai.com) Camera Control Tool for Windows 98/NT/2000 can be downloaded. The control tool contents a camera control program and tools for making your own program. For the integrator and experienced user, the Camera Control Toll is much more than a program with a window interface. It also provides an easy and efficient ActiveX interface built for MS Windows 98, ME, NT and 2000. The OCX interface has the ability to connect to the camera using the serial interface of the PC by reading and writing properties for the camera. This integration requires simple programming skills within Visual Basic, Visual C++ or similar languages in a Microsoft Windows environment. Below the different windows are shown.



Fig. 34. About window.



Fig. 33. Camera Control Tool main bar.

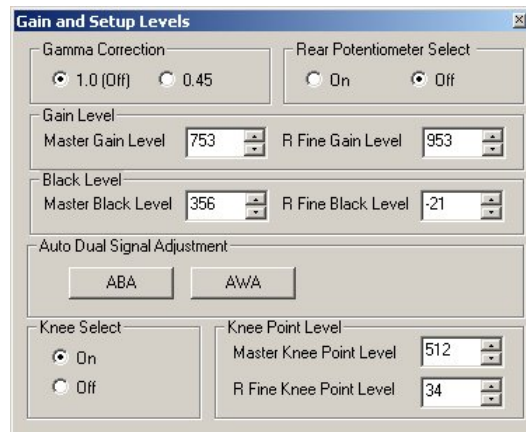

Fig.35. Gain setup window.

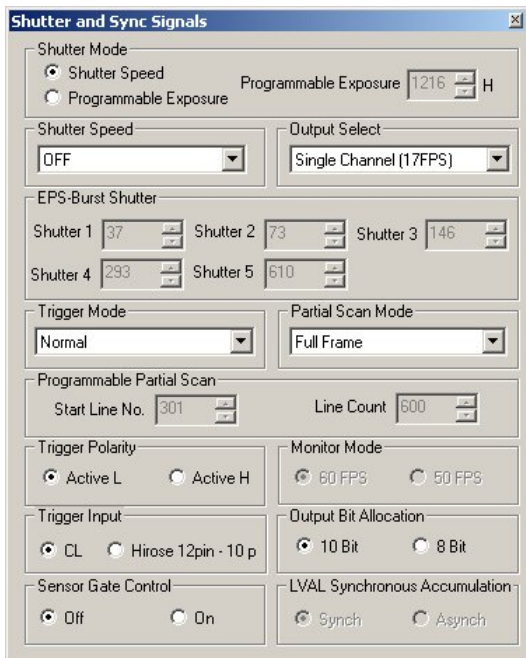

Fig. 36 Shutter and Sync window.

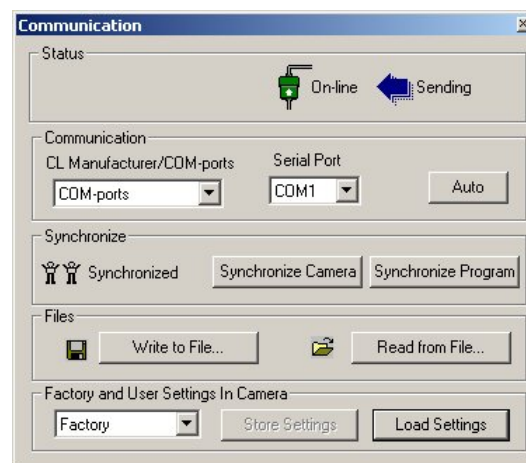

Fig. 37. Communication window.

## 8. External Appearance and Dimensions

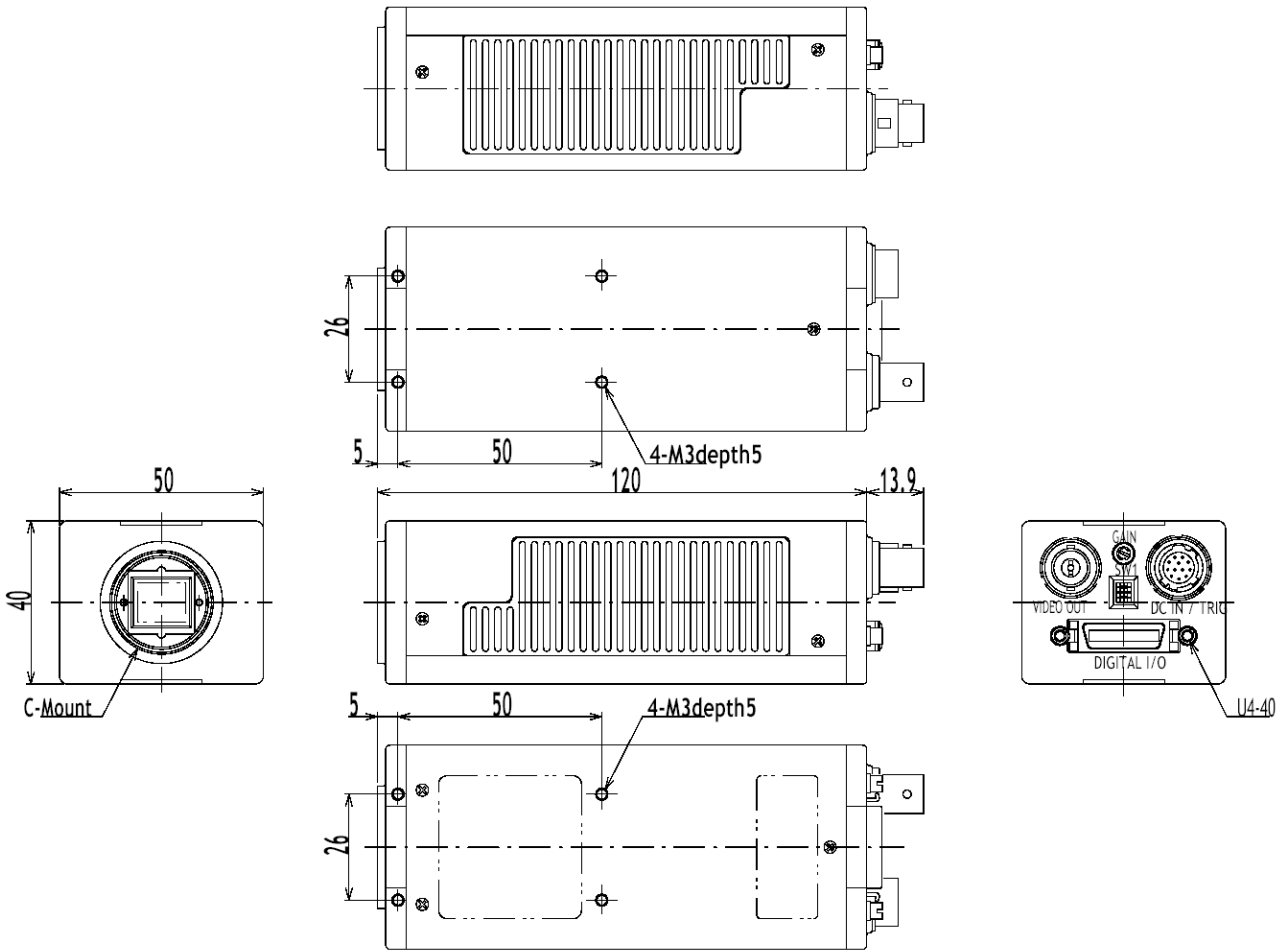

Fig. 38. Outline.

## 9. Specifications

### 9.1. Spectral sensitivity

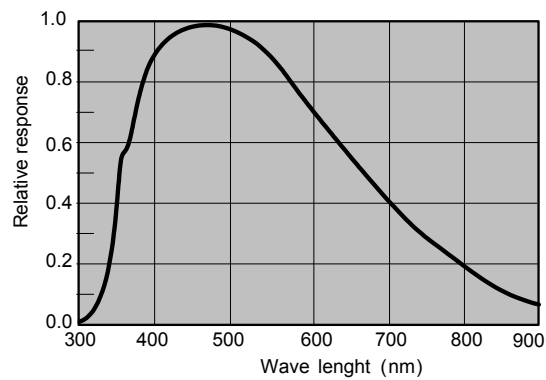

Fig. 39. Spectral sensitivity for M2.

## CV-M2

### 9.2. Specification table

Specifications	CV-M2
Scanning system	Progressive 1216 lines 17 frames/sec.
Pixel clock	40.00 MHz
Line frequency, single output dual output	20.88 kHz (1916 pixel clock/line). (H = 47.9 $\mu$ sec) 36.63 kHz (1092 pixel clock/line). (H = 27.3 $\mu$ sec)
Frame rate, single output dual output	17.17 frames/sec. (1216 lines/frame) 30.12 frames/sec. (1216 lines/frame)
CCD sensor	1" progressive scan monochrome IT CCD Kodak KAI-2000M
Sensing area	11.8 (h) x 8.9 (v) mm
Cell size	7.4 (h) x 7.4 (v) $\mu$ m
Effective pixels	1600 (h) x 1200 (v)
Pixels in video output	1 channel      2 channel
Full	1600 (h) x 1200 (v)      17.17 FPS      30.12 FPS
1/2 partial	1600 (h) x 600 (v)      32.52 FPS      54.67 FPS
1/4 partial	1600 (h) x 300 (v)      57.99 FPS      91.58 FPS
1/8 partial	1600 (h) x 150 (v)      95.77 FPS      138.75 FPS
Variable scan	1600 (h) x 50 (v) to 1200 (v)      <167 FPS      <208 FPS
Sensitivity on sensor	1.4 lx (100% video out. Min. gain. 0 dB) 0.2 lx (50% video out. Max. gain. 12 dB)
S/N ratio	>50 dB
Video output digital single digital dual	10 or 8 bit in Camera Link 2 x 10/8 bit in Camera Link
Monitor video output. Analogue	Composite 1.0 Vpp, 75 $\Omega$ (50 or 60 FPS. 15.734 kHz)
Iris video output. Analogue	0.7 Vpp, 75 $\Omega$ (for iris control)
Gamma	1.0 or 0.45 (Single channel only)
Knee function	Slope 100% to 20%. Knee point adjustable
Gain	Manual, potentiometer or remote
Gain range	-3 to +12 dB (0 - 4095)
Synchronization	Int. X-tal. Ext. random trigger (LVAL synch. or asynch.)
Inputs TTL Camera Link	Ext. trigger TTL 4 V $\pm$ 2 V Ext. trigger
Outputs TTL Camera Link	EEN output Pixel clock output D0-D9 output DVAL output LVAL output FVAL output EEN output. (Not specified by Camera Link).
Control interface	TXD and RXD via RS 232C TDX and RDX via Camera Link
Trigger modes	Continuous, Edge pre-select, Pulse width control, Reset Continuous Trigger, PIV and EPS Burst (with 5 programmable shutter times)
Read out modes	Single or dual digital output. Analogue output. Partial scan.
Shutter speed (fixed)	Off, 1/60, 1/120, 1/250, 1/500, 1/1000, 1/2000, 1/4000, 1/8000, 1/14,000 second
Pulse width control	1.5 H to $\infty$ . (>72 $\mu$ sec.) <2 sec. is recommended
Programmable exposure	1.5 H to 1216.5 H (71.9 $\mu$ sec. to 58.2 msec.) Single channel 1.5 H to 1216.5 H (41 $\mu$ sec. to 33.2 msec.) Dual channel
Variable scan	50 to 1200 lines
Functions controlled by RS 232C	Shutter, Trigger, Scanning, Readout, Trigger input, Video level, Set-up level and Gain
Operating temperature	-5°C to +45°C
Humidity	20 - 80% non-condensing
Storage temp/humidity	-25°C to +60°C/20 - 90% non-condensing
Power	12V DC $\pm$ 10%. 6.6 W
Lens mount	C-mount
Dimensions	40 x 50 x 120 mm (HxWxD)
Weight	310g



## 10. Appendix

### Precautions

Personnel not trained in dealing with similar electronic devices should not service this camera. The camera contains components sensitive to electrostatic discharge. The handling of these devices should follow the requirements of electrostatic sensitive components.

Do not attempt to disassemble this camera.

Do not expose this camera to rain or moisture.

Do not face this camera towards the sun, extreme bright light or light reflecting objects.

When this camera is not in use, put the supplied lens cap on the lens mount.

Handle this camera with the maximum care.

Operate this camera only from the type of power source indicated on the camera.

Power off the camera during any modification such as changes of jumper and switch setting.

### Typical CCD Characteristics

The following effects may be observed on the video monitor screen. They do not indicate any fault of the CCD camera, but do associate with typical CCD characteristics.

#### V. Smear

Due to an excessive bright object such as electric lighting, sun or strong reflection, vertical smear may be visible on the video monitor screen. This phenomenon is related to the characteristics of the Interline Transfer System employed in the CCD.

#### V. Aliasing

When the CCD camera captures stripes, straight lines or similar sharp patterns, jagged image on the monitor may appear.

#### Blemishes

Some pixel defects can occur, but this does not have an effect on the practical operation.

#### Patterned Noise

When the CCD camera captures a dark object at high temperature or is used for long time integration, fixed pattern noise (shown as white dots) may appear on the video monitor screen.

## 11. Users Record

Camera type: CV-M2  
Revision: (Revision A)  
Serial No. ....  
Firmware version. ....  
Camera ID. ....

*For camera revision history, please contact your local JAI distributor.*

---

**Users Mode Settings.**

**Users Modifications.**



**DECLARATION OF CONFORMITY**  
AS DEFINED BY THE COUNCIL DIRECTIVE  
89/336/EEC  
EMC (ELECTROMAGNETIC COMPABILITY)  
WE HEREWITH DECLARE THAT THIS PRODUCT  
COMPLIES WITH THE FOLOWING PROVISIONS APPLYING TO IT.  
EN-50081-1  
EN-50082-1

---

Company and product names mentioned in this manual are trademarks or registered trademarks of their respective owners.  
JAI A-S cannot be held responsible for any technical or typographical errors and reserves the right to make changes to products and documentation without prior notification.

---

JAI A-S, Denmark  
Phone +45 4457 8888  
Fax +45 4491 8880  
www.jai.com

JAI UK Ltd, England  
Phone +44 0 1895 821 481  
Fax +44 0 1895 824 466  
www.jai.com

JAI Corporation, Japan  
Phone +81 45 933 5400  
Fax +81 45 931 6142  
www.jai-corp.co.jp

JAI Pulnix Inc, USA  
Phone (Toll-Free) +1 877 472-5909  
Phone +1 408-747-0300  
www.jai.com



**THE MECHADEMIC COMPANY**

---

